



المستقبل للسيراميك والبورسلان

## PORCELAIN TILE





المستقبل للسيراميك والبورسلان



## INDEX

DIGITAL GLAZED PORCELAIN	CANYON	4
	EXPERIENCE	10
	GEMS	16
	JUDY	22
	MOONSCAPE	28
	ORIGINS	34
	ROAD	40
DIGITAL MARBLES	EMPERADOR	48
	FIORDIBOSCO	54
	CALDIA	60
	MONTECHIARO	66
GLAZED PORCELAIN STONEWARE	CARPET	74
	CLUB	80
	CONCRETE	88
	FOSSIL	94
	MODERN	100
	NATURAL	106
	PETRA	112
	QUARZITE	118
	SILK	124
	STONE	130
	UNIVERSE	136
	WILD	142
TECHNICAL PORCELAIN FULL BODY	COMPACT	150
	CROMA MALL	156
	GRANIT	164
	LEGEND	172

### Legend.

	Thickness
	Matt
	Lappato
	Polish
	Rectified

### Future's vision

Distinction and diffusion the ceramic and porcelain manufacture in Saudi Arabia.

### Our Mission

We work in Future Factory to provide great products and high quality to satisfy the aspirations of business, to ensure the continuous development through optimizing investment of available resources and renewable technologies and actively contribute to development our country economically and socially in order to achieve ambitions of our customers and partners in the industry.

### Our Slogan

Work together to best industry



DIGITAL  
GLAZED  
PORCELAIN



CANYON.



CANYON.  
RUST 45x45cm 18"x18"  
BEIGE 30x60cm 12"x24"

# CANYON.

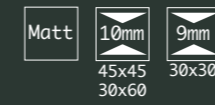

## COLOURS.



BEIGE.

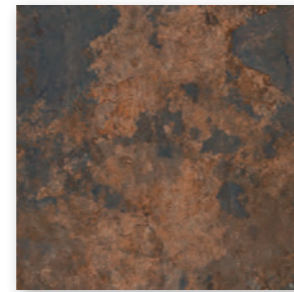

RUST.

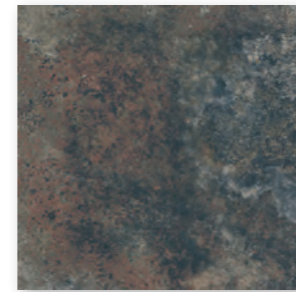

BLACK.

## SIZES & TRIMS.



45x45cm 18"x18"

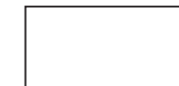

30x60cm 12"x24"



30x30cm 12"x12"



SKIRTING 8x60cm 3"x24"

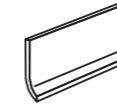

COVE BASE 11,5x30cm 4.6"x12"



INSIDE COVE CORNER 2,5x11,5cm 1"x4.6"



OUTSIDE COVE CORNER 2,5x11,5cm 1"x4.6"

## PACKING AND WEIGHT

SIZE	THICKNESS	PCS/BOX	SQM/BOX	BOX/PALLET	Kg/BOX	Kg/PALLET	SQMS/PALLET
45x45	10	6	1,215	52	27,42	1445,84	63,18
30x60	10	6	1,08	48	24,24	1183,52	51,84
30x30	9	13	1,17	46	23,66	1108,36	53,82





EXPERIENCE .

OAK 15x90cm 6"x36"



EXPERIENCE .  
WENGÉ 22,5x90cm 9"x36" - 15x90cm 6"x36"





# EXPERIENCE.

## SIZES & TRIMS.

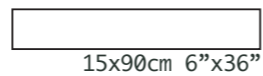
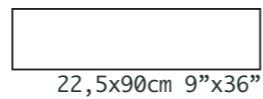
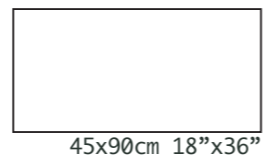

SKIRTING 8x60cm 3"x24"

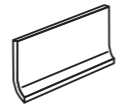

COVE BASE 11,5x30cm 4.6"x12"



INSIDE COVE CORNER 2,5x11,5cm 1"x4.6"



OUTSIDE COVE CORNER 2,5x11,5cm 1"x4.6"

## COLOURS.



WHITE.



GREY.



BAMBOO.



OAK.



WENGÉ.

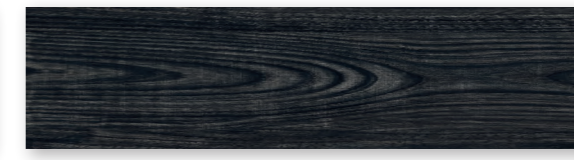

BLACK.

## PACKING AND WEIGHT.

SIZE	THICKNESS	PCS/BOX	SQM/BOX	BOX/PALLET	Kg/BOX	Kg/PALLET	SQMS/PALLET
45x90	11	3	1,215	20	30	620,00	24,30
22,5x90	11	6	1,215	32	30	980,00	38,88







GEMS.  
PEARL 60x60cm 24"x24"  
OPAL 30x60cm 12"x24"

# GEMS.

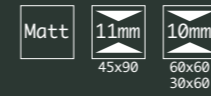

## COLOURS.



PEARL.



AMBER.



DIAMOND.



OPAL.

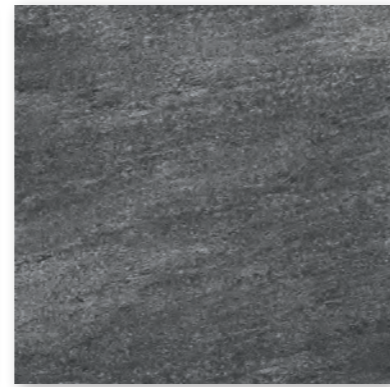

OBSIDIAN.

## SIZES & TRIMS.



60x60cm 24"x24"



30x60cm 12"x24"



45x90cm 18"x36"



SKIRTING 8x60cm 3"x24"

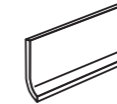

COVE BASE 11,5x30cm 4.6"x12"



INSIDE COVE CORNER 2,5x11,5cm 1"x4.6"



OUTSIDE COVE CORNER 2,5x11,5cm 1"x4.6"

## PACKING AND WEIGHT.

SIZE	THICKNESS	PCS/BOX	SQM/BOX	BOX/PALLET	Kg/BOX	Kg/PALLET	SQMS/PALLET
60x60	10	4	1,44	30	33,20	1016,00	43,20
30x60	10	6	1,08	48	24,24	1183,52	51,84
45x90	11	3	1,215	20	30	620,00	24,30





CREAM 45x45cm 18"x18"



JUDY.



JUDY.  
ORANGE 45x45cm 18"x18"

# JUDY.



## COLOURS.



CREAM.



BEIGE.



ORANGE.

## SIZES & TRIMS.



45x45cm 18"x18"



30x30cm 12"x12"



SKIRTING 8x60cm 3"x24"



COVE BASE 11,5x30cm 4.6"x12"



INSIDE COVE CORNER 2,5x11,5cm 1"x4.6"



OUTSIDE COVE CORNER 2,5x11,5cm 1"x4.6"

## PACKING AND WEIGHT.

SIZE	THICKNESS	PCS/BOX	SQM/BOX	BOX/PALLET	Kg/BOX	Kg/PALLET	SQMS/PALLET
45x45	10	6	1,215	52	27,42	1445,84	63,18
30x30	9	13	1,17	46	23,66	1108,36	53,82





## MOONSCAPE .

IVORY 30x60cm 12"x24"





MOONSCAPE.  
NUT 60x60cm 24"x24"



# MOONSCAPE.

## SIZES & TRIMS.

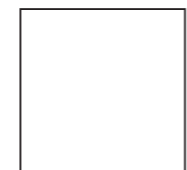

60x60cm 24"x24"



30x60cm 12"x24"



SKIRTING 8x60cm 3"x24"

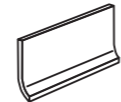

COVE BASE 11,5x30cm 4.6"x12"



INSIDE COVE CORNER 2,5x11,5cm 1"x4.6"



OUTSIDE COVE CORNER 2,5x11,5cm 1"x4.6"

## COLOURS.



IVORY.



CREAM.



NUT.

## PACKING AND WEIGHT

SIZE	THICKNESS	PCS/BOX	SQM/BOX	BOX/PALLET	Kg/BOX	Kg/PALLET	SQMS/PALLET
60x60	10	4	1,44	30	33,20	1016,00	43,20
30x60	10	6	1,08	48	24,24	1183,52	51,84





ORIGINS.



ORIGINS.  
EARTH 60x60cm 24"x24"  
AIR 30x60cm 12"x24"



# ORIGINS.

Lapp

Matt 10mm

## COLOURS.



AIR.



DESERT.

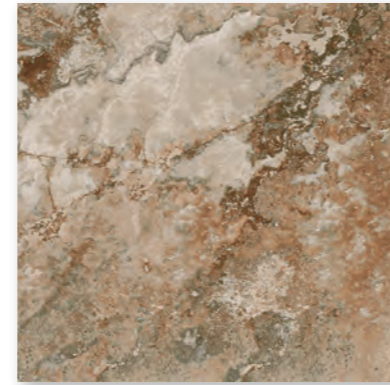

EARTH.

## SIZES & TRIMS.



60x60cm 24"x24"

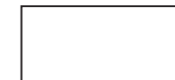

30x60cm 12"x24"



SKIRTING 8x60cm 3"x24"

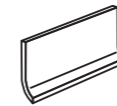

COVE BASE 11,5x30cm 4.6"x12"



INSIDE COVE CORNER 2,5x11,5cm 1"x4.6"



OUTSIDE COVE CORNER 2,5x11,5cm 1"x4.6"

## PACKING AND WEIGHT.

SIZE	THICKNESS	PCS/BOX	SQM/BOX	BOX/PALLET	Kg/BOX	Kg/PALLET	SQMS/PALLET
60x60	10	4	1,44	30	33,20	1016,00	43,20
30x60	10	6	1,08	48	24,24	1183,52	51,84



DESERT 30x60cm 12"x24"



ROAD.





# ROAD.

## SIZES & TRIMS.

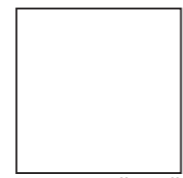

60x60cm 24"x24"

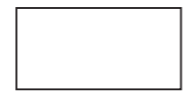

30x60cm 12"x24"



SKIRTING 8x60cm 3"x24"

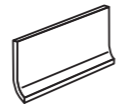

COVE BASE 11,5x30cm 4.6"x12"



INSIDE COVE CORNER 2,5x11,5cm 1"x4.6"



OUTSIDE COVE CORNER 2,5x11,5cm 1"x4.6"

## COLOURS.



LIGHT GREY.



IVORY.



GREY.



TAUPE.

## PACKING AND WEIGHT.

SIZE	THICKNESS	PCS/BOX	SQM/BOX	BOX/PALLET	Kg/BOX	Kg/PALLET	SQMS/PALLET
60x60	10	4	1,44	30	33,20	1016,00	43,20
30x60	10	6	1,08	48	24,24	1183,52	51,84







## DIGITAL MARBLES



EMPERADOR.









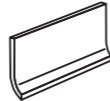

# EMPERADOR.

## SIZES & TRIMS.

-   
60x60cm 24"x24"
-   
SKIRTING 8x60cm 3"x24"
-   
COVE BASE 11,5x30cm 4.6"x12"
-   
INSIDE COVE CORNER 2,5x11,5cm 1"x4.6"
-   
OUTSIDE COVE CORNER 2,5x11,5cm 1"x4.6"

## COLOURS.

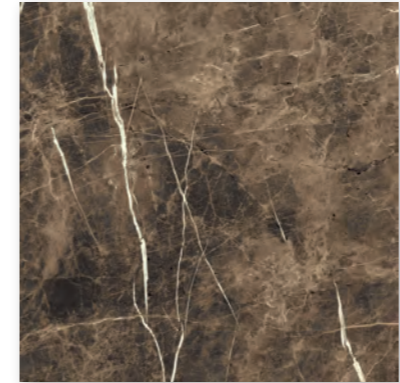

BROWN.

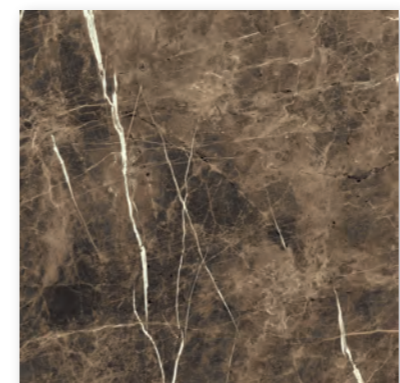

BROWN.



## PACKING AND WEIGHT.

SIZE	THICKNESS	PCS/BOX	SQM/BOX	BOX/PALLET	Kg/BOX	Kg/PALLET	SQMS/PALLET
60x60	10	4	1,44	30	33,20	1016,00	43,20





FIORDIBOSCO.





Lapp

10mm  
Matt

# FIORDIBOSCO.

## SIZES & TRIMS.

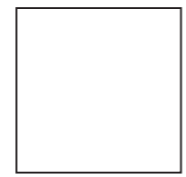

60x60cm 24"x24"



SKIRTING 8x60cm 3"x24"

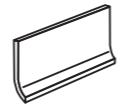

COVE BASE 11,5x30cm 4.6"x12"



INSIDE COVE CORNER 2,5x11,5cm 1"x4.6"



OUTSIDE COVE CORNER 2,5x11,5cm 1"x4.6"

## COLOURS.

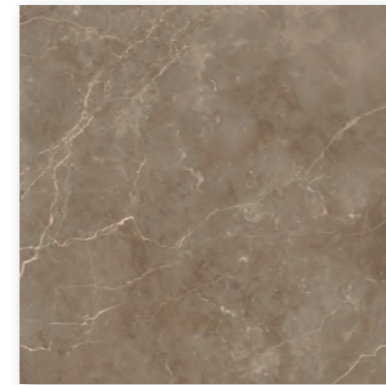

BROWN.



BROWN.

Lapp

## PACKING AND WEIGHT.

SIZE	THICKNESS	PCS/BOX	SQM/BOX	BOX/PALLET	Kg/BOX	Kg/PALLET	SQMS/PALLET
60x60	10	4	1,44	30	33,20	1016,00	43,20





CALDIA.





CALDIA.  
GREY 60x60cm 24"x24"

# CALDIA.

Lapp

Matt 10mm

## COLOURS.

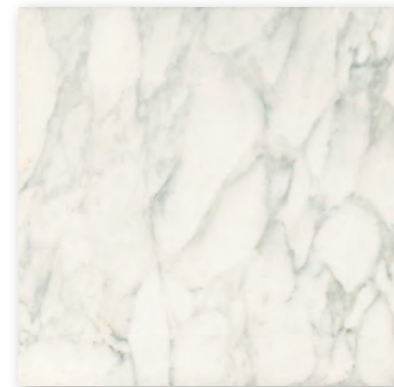

GREY.



BEIGE.

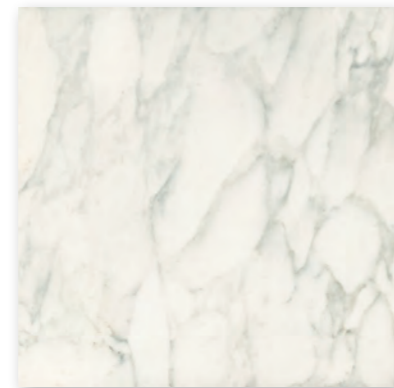

GREY.



BEIGE.

Lapp

## SIZES & TRIMS.

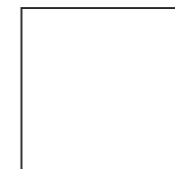

60x60cm 24"x24"



SKIRTING 8x60cm 3"x24"

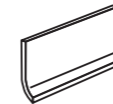

COVE BASE 11,5x30cm 4.6"x12"



INSIDE COVE CORNER 2,5x11,5cm 1"x4.6"



OUTSIDE COVE CORNER 2,5x11,5cm 1"x4.6"

## PACKING AND WEIGHT.

SIZE	THICKNESS	PCS/BOX	SQM/BOX	BOX/PALLET	Kg/BOX	Kg/PALLET	SQMS/PALLET
60x60	10	4	1,44	30	33,20	1016,00	43,20





MONTECHIARO .



MONTECHIARO.  
BEIGE 60x60cm 24"x24"



# MONTECHIARO.

## SIZES & TRIMS.

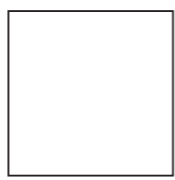

60x60cm 24"x24"



SKIRTING 8x60cm 3"x24"

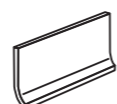

COVE BASE 11,5x30cm 4.6"x12"



INSIDE COVE CORNER 2,5x11,5cm 1"x4.6"



OUTSIDE COVE CORNER 2,5x11,5cm 1"x4.6"

## COLOURS.



BEIGE.



BEIGE.

## PACKING AND WEIGHT.

SIZE	THICKNESS	PCS/BOX	SQM/BOX	BOX/PALLET	Kg/BOX	Kg/PALLET	SQMS/PALLET
60x60	10	4	1,44	30	33,20	1016,00	43,20





GLAZED  
PORCELAIN  
STONEWARE



CARPET .



CARPET.  
BLACK 60x60cm 24"x24"  
LISTEL ISLAND 3,5x30cm 1.4"x12"  
SKIRTING BLACK 8x60cm 3"x24"



# CARPET.

Lapp

Matt 10mm

## COLOURS.

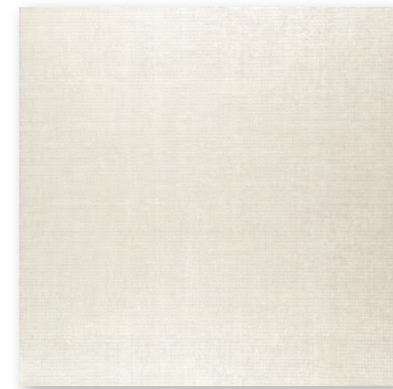

WHITE.

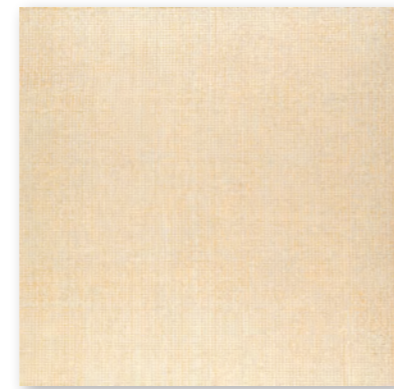

BEIGE.

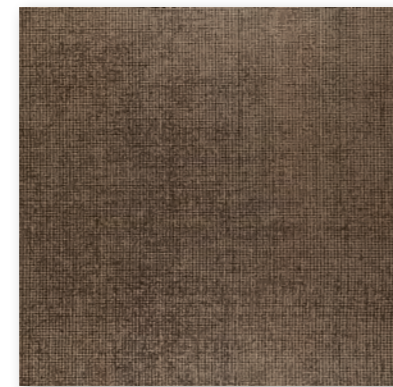

BROWN.

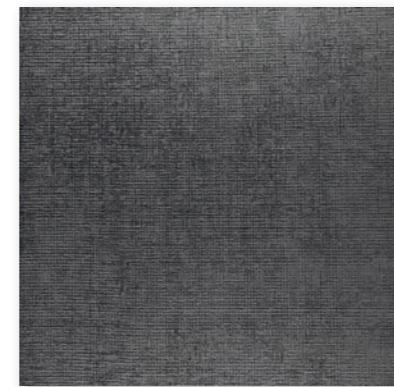

BLACK.

## DECORS.



LISTEL ISLAND.  
3,5x30cm 1.4"x12"

## SIZES & TRIMS.



60x60cm 24"x24"



30x60cm 12"x24"



SKIRTING 8x60cm 3"x24"

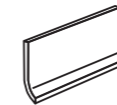

COVE BASE 11,5x30cm 4.6"x12"



INSIDE COVE CORNER 2,5x11,5cm 1"x4.6"



OUTSIDE COVE CORNER 2,5x11,5cm 1"x4.6"

## PACKING AND WEIGHT.

SIZE	THICKNESS	PCS/BOX	SQM/BOX	BOX/PALLET	Kg/BOX	Kg/PALLET	SQMS/PALLET
60x60	10	4	1,44	30	33,20	1016,00	43,20
30x60	10	6	1,08	48	24,24	1183,52	51,84
3,5x30	-	16	-	-	-	-	-





CLUB .





# CLUB.

## SIZES & TRIMS.



60x60cm 24"x24"



30x60cm 12"x24"



SKIRTING 8x60cm 3"x24"

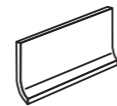

COVE BASE 11,5x30cm 4.6"x12"



INSIDE COVE CORNER 2,5x11,5cm 1"x4.6"



OUTSIDE COVE CORNER 2,5x11,5cm 1"x4.6"

## COLOURS.



WHITE.



ALMOND.



BEIGE.



BROWN.



BLACK.

## PACKING AND WEIGHT.

SIZE	THICKNESS	PCS/BOX	SQM/BOX	BOX/PALLET	Kg/BOX	Kg/PALLET	SQMS/PALLET
60x60	10	4	1,44	30	33,20	1016,00	43,20
30x60	10	6	1,08	48	24,24	1183,52	51,84
3x60	-	8	-	-	-	-	-



# CLUB.

BLACK LAPPATO 60x60cm 24"x24"  
 BLACK DECOR 60x60cm 24"x24"  
 SKIRTING BLACK 8x60cm 3"x24"



## DECORS.



WHITE.



ALMOND.



BEIGE.



BROWN.



BLACK.

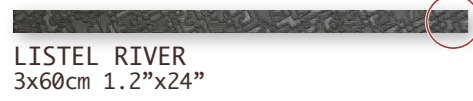

LISTEL RIVER  
3x60cm 1.2"x24"

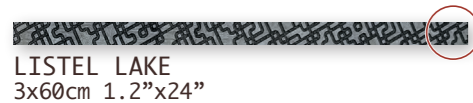
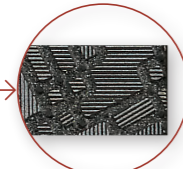

LISTEL LAKE  
3x60cm 1.2"x24"

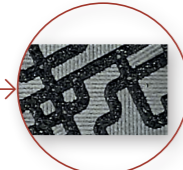



CONCRETE .



CONCRETE .  
GREY 60x60cm 24"x24" - 30x60cm 12"x24"  
MIX ERCOLANO 30x30(5x5)cm 12"x12"(2"x2")

# CONCRETE.

Matt 10mm

## DECORS.



**MIX ERCOLANO**  
30x30(5x5)cm  
12"x12"(2"x2")  
WHITE + GREY + INSERT SILVER



**MIX POMPEI**  
30x30(5x5)cm  
12"x12"(2"x2")  
BEIGE + ALMOND + INSERT GOLD

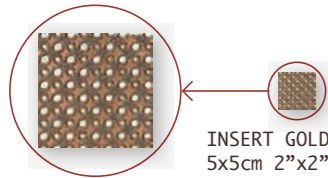

**INSERT GOLD**  
5x5cm 2"x2"

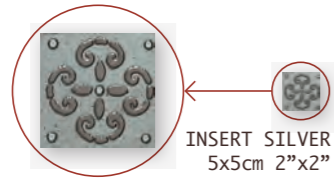

**INSERT SILVER**  
5x5cm 2"x2"

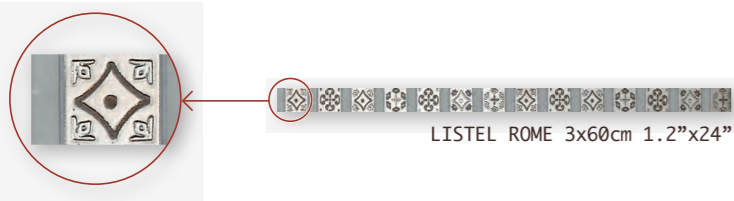

**LISTEL ROME** 3x60cm 1.2"x24"

## COLOURS.



## SIZES & TRIMS.

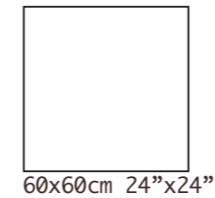

60x60cm 24"x24"

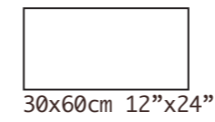

30x60cm 12"x24"



SKIRTING 8x60cm 3"x24"

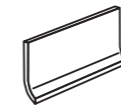

COVE BASE 11,5x30cm 4.6"x12"



INSIDE COVE CORNER 2,5x11,5cm 1"x4.6"



OUTSIDE COVE CORNER 2,5x11,5cm 1"x4.6"

## PACKING AND WEIGHT.

SIZE	THICKNESS	PCS/BOX	SQM/BOX	BOX/PALLET	Kg/BOX	Kg/PALLET	SQMS/PALLET
60x60	10	4	1,44	30	33,20	1016,00	43,20
30x60	10	6	1,08	48	24,24	1183,52	51,84
3x60	-	8	-	-	-	-	-
5x5	-	28	-	-	-	-	-





FOSSIL.



FOSSIL.  
BROWN LAPPATO 30x60cm 12"x24"  
LISTEL CREEK 3x60cm 1.2"x24"



# FOSSIL.

## SIZES & TRIMS.

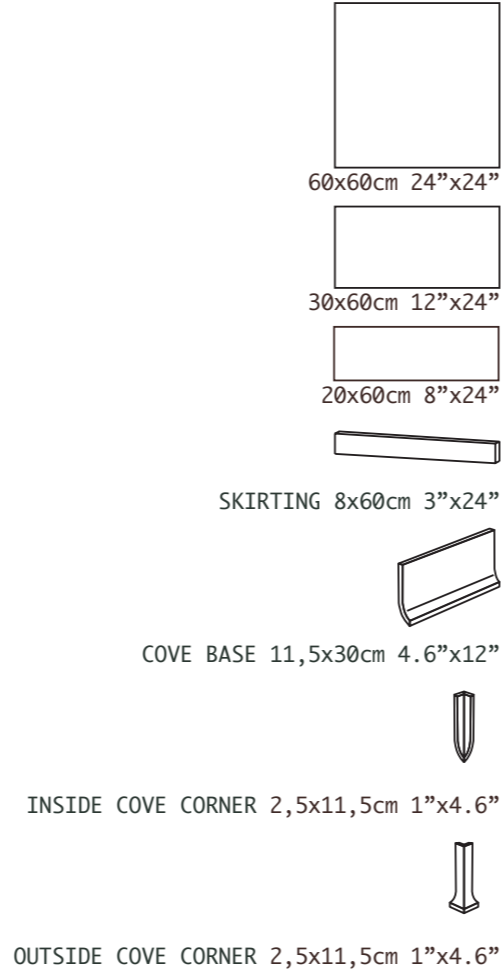

## COLOURS.



## DECORS.

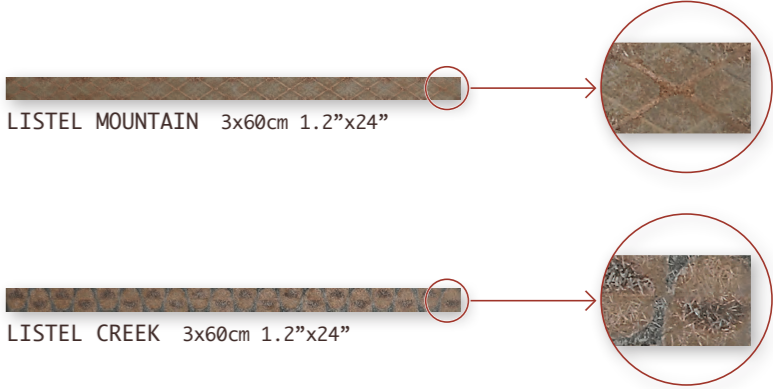

## PACKING AND WEIGHT.

SIZE	THICKNESS	PCS/BOX	SQM/BOX	BOX/PALLET	Kg/BOX	Kg/PALLET	SQMS/PALLET
60x60	10	4	1,44	30	33,20	1016,00	43,20
30x60	10	6	1,08	48	24,24	1183,52	51,84
20x60	-	-	-	-	-	-	-
3x60	-	8	-	-	-	-	-





MODERN.



MODERN.  
AVIO 60x60cm 24"x24"  
MIX ANTARTIC 30x30(3,5x30)cm 12"x12"(1.4"x12")  
SKIRTING AVIO 8x60cm 3"x24"

# MODERN.

Lapp

Matt 10mm

## DECORS.

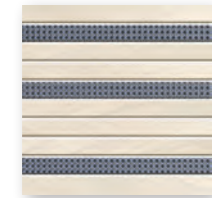

MIX ARCTIC.  
30x30(3,5x30)cm  
12"x12"(1.4"x12")  
WHITE + INSERT ICE

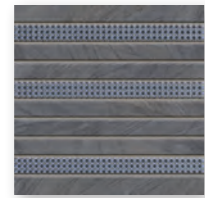

MIX ANTARCTIC.  
30x30(3,5x30)cm  
12"x12"(1.4"x12")  
AVIO + INSERT ICE

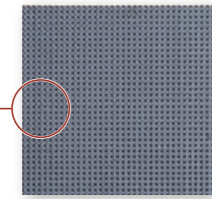

INSERT ICE.  
30x30cm 12"x12"



MIX SAHARA.  
30x30(3,5x30)cm  
12"x12"(1.4"x12")  
ALMOND + INSERT SAND

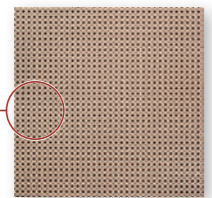

INSERT SAND.  
30x30cm 12"x12"



MIX NAFUD.  
30x30(3,5x30)cm  
12"x12"(1.4"x12")  
NUT + INSERT SAND

## COLOURS.

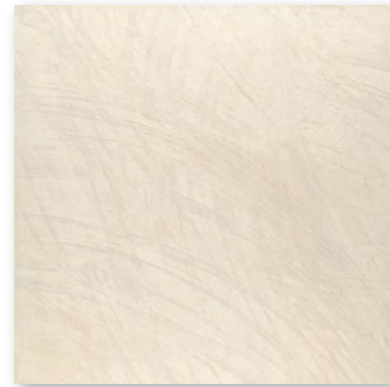

WHITE.

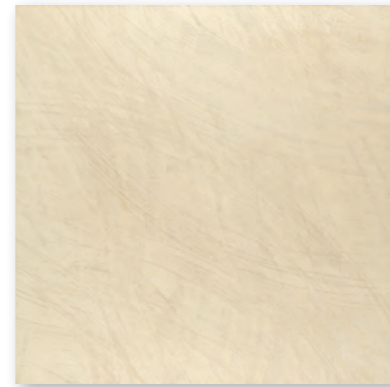

ALMOND.

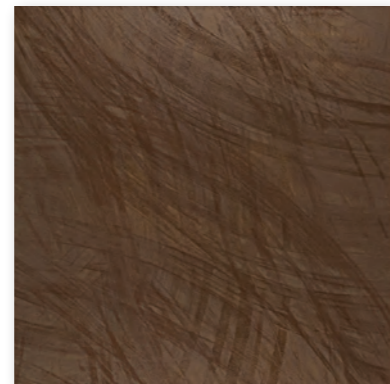

NUT.

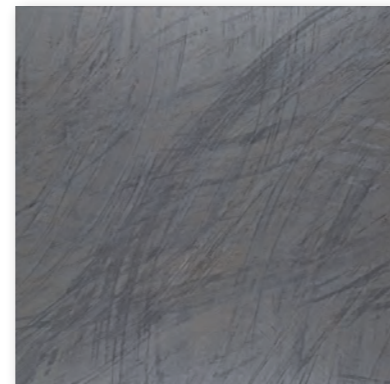

AVIO.

## SIZES & TRIMS.



60x60cm 24"x24"

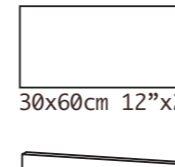

30x60cm 12"x24"



SKIRTING 8x60cm 3"x24"

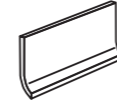

COVE BASE 11,5x30cm 4.6"x12"



INSIDE COVE CORNER 2,5x11,5cm 1"x4.6"



OUTSIDE COVE CORNER 2,5x11,5cm 1"x4.6"

## PACKING AND WEIGHT.

SIZE	THICKNESS	PCS/BOX	SQM/BOX	BOX/PALLET	Kg/BOX	Kg/PALLET	SQMS/PALLET
60x60	10	4	1,44	30	33,20	1016,00	43,20
30x60	10	6	1,08	48	24,24	1183,52	51,84
30x30	-	6	-	-	-	-	-





NATURAL .



NATURAL .  
GOLD 60x60cm 24"x24"  
MOSAIC GOLD 30x30(5x5)cm 12"x12"(2"x2")





# NATURAL.

## SIZES & TRIMS.

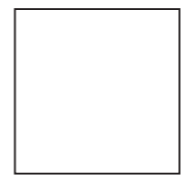

60x60cm 24"x24"



30x60cm 12"x24"



SKIRTING 8x60cm 3"x24"

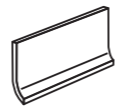

COVE BASE 11,5x30cm 4.6"x12"



INSIDE COVE CORNER 2,5x11,5cm 1"x4.6"



OUTSIDE COVE CORNER 2,5x11,5cm 1"x4.6"

## COLOURS.



IVORY.

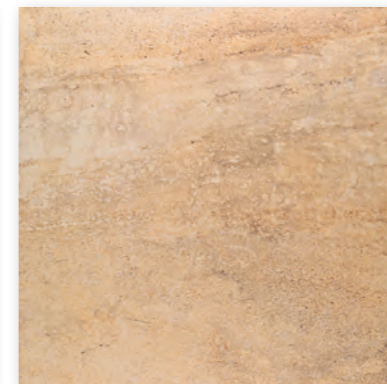

GOLD.



BROWN.



BLACK.

## MOSAICS ON THE NET.



IVORY.  
30x30(5x5)cm  
12"x12"(2"x2")

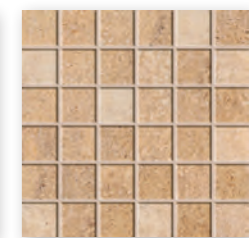

GOLD.  
30x30(5x5)cm  
12"x12"(2"x2")



BROWN.  
30x30(5x5)cm  
12"x12"(2"x2")

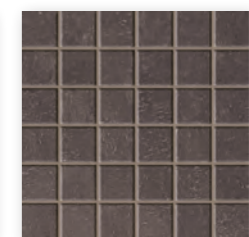

BLACK.  
30x30(5x5)cm  
12"x12"(2"x2")

## DECORS.



LISTEL SKY  
3,5x30cm 1.4"x12"

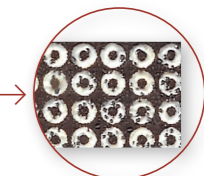

## PACKING AND WEIGHT.

SIZE	THICKNESS	PCS/BOX	SQM/BOX	BOX/PALLET	Kg/BOX	Kg/PALLET	SQMS/PALLET
60x60	10	4	1,44	30	33,20	1016,00	43,20
30x60	10	6	1,08	48	24,24	1183,52	51,84
3,5x30	-	14	-	-	-	-	-





PETRA.



PETRA.  
GOLDEN 60x60cm 24"x24" - 30x30cm 12"x12"  
LISTEL SQUARE 5x30cm 2"x12"



# PETRA.

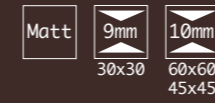

## COLOURS.



## DECORS.

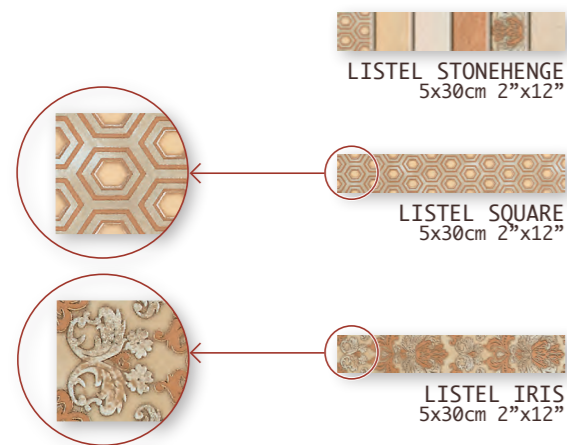

## SIZES & TRIMS.

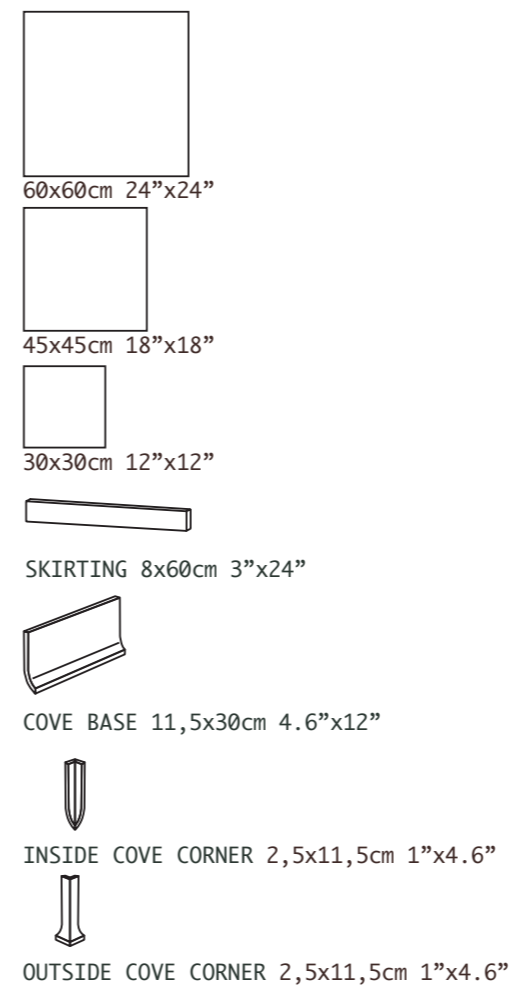

## PACKING AND WEIGHT.

SIZE	THICKNESS	PCS/BOX	SQM/BOX	BOX/PALLET	Kg/BOX	Kg/PALLET	SQMS/PALLET
60x60	10	4	1,44	30	33,20	1016,00	43,20
45x45	10	6	1,215	52	27,42	1445,84	63,18
30x30	9	13	1,17	46	23,66	1108,36	53,82
5x30	-	18	-	-	-	-	-





QUARZITE .



QUARZITE .  
GREY 45x45cm 18"x18"  
MOSAIC GREY 30x30(5x5)cm 12"x12"(2"x2")



# QUARZITE.

## SIZES & TRIMS.

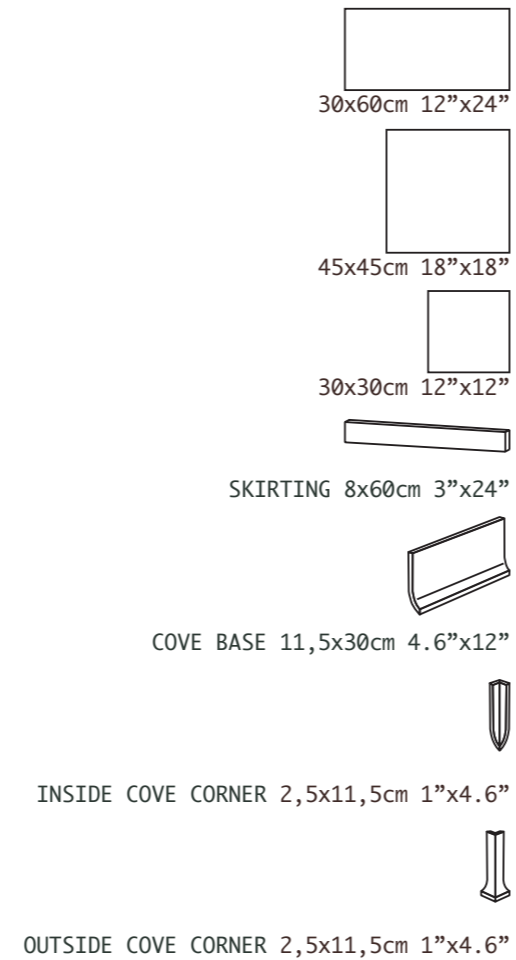

## COLOURS.



## MOSAICS ON THE NET.

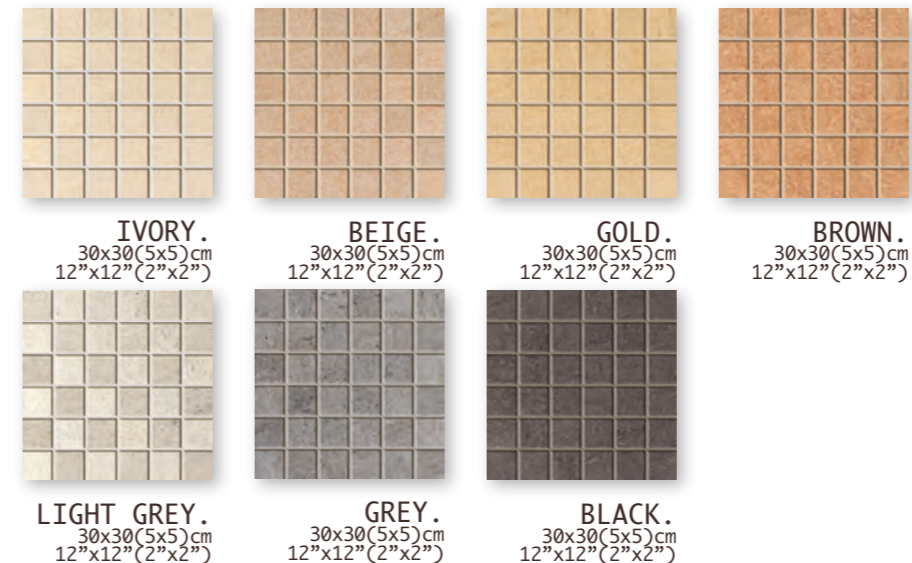

## DECORS.

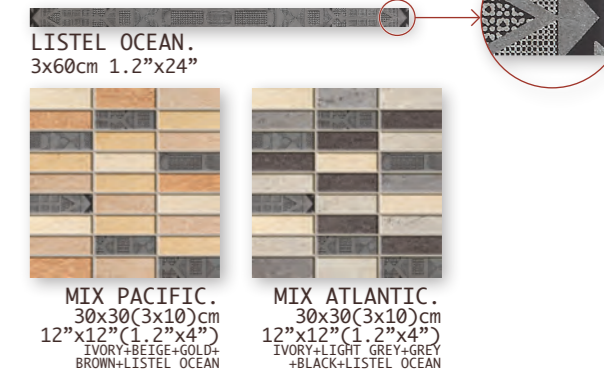

## PACKING AND WEIGHT.

SIZE	THICKNESS	PCS/BOX	SQM/BOX	BOX/PALLET	Kg/BOX	Kg/PALLET	SQMS/PALLET
30x60	10	6	1,08	48	24,24	1183,52	51,84
45x45	10	6	1,215	52	27,42	1445,84	63,18
30x30	9	13	1,17	46	23,66	1108,36	53,82
3x60	-	8	-	-	-	-	-





SILK.





SILK.  
WHITE 40x40cm 16"x16"

# SILK.



## COLOURS.

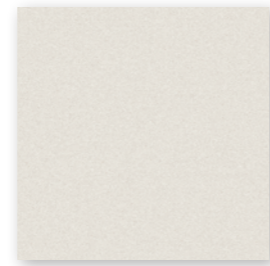

WHITE.

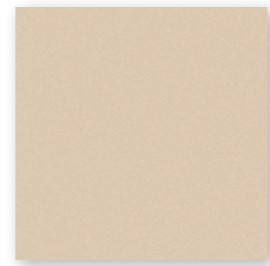

BEIGE.

## SIZES & TRIMS.



40x40cm 16"x16"



SKIRTING 8x60cm 3"x24"

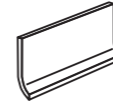

COVE BASE 11,5x30cm 4.6"x12"



INSIDE COVE CORNER 2,5x11,5cm 1"x4.6"



OUTSIDE COVE CORNER 2,5x11,5cm 1"x4.6"

## PACKING AND WEIGHT.

SIZE	THICKNESS	PCS/BOX	SQM/BOX	BOX/PALLET	Kg/BOX	Kg/PALLET	SQMS/PALLET
40x40	9	9	1,44	48	29,52	1436,96	69,12





STONE .



STONE.  
IVORY LAPPATO 60x60cm 24"x24"  
MOSAIC GOLD LAPPATO 30x30(5x5x)cm 12"x12"(2"x2")



# STONE.

Lapp

Matt

9mm

30x30

10mm

60x60

30x60

45x45

## COLOURS.



IVORY.



GOLD.



BROWN.



GREY.

## DECORS.



INSERT FLORENCE.  
15x15cm 6"x6"



INSERT VENICE.  
15x15cm 6"x6"

## MOSAICS ON THE NET.



IVORY.  
30x30(5x5)cm  
12"x12"(2"x2")



GOLD.  
30x30(5x5)cm  
12"x12"(2"x2")



BROWN.  
30x30(5x5)cm  
12"x12"(2"x2")



GREY.  
30x30(5x5)cm  
12"x12"(2"x2")

## SIZES & TRIMS.



60x60cm 24"x24"

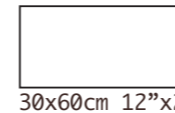

30x60cm 12"x24"



45x45cm 18"x18"



30x30cm 12"x12"



SKIRTING 8x60cm 3"x24"

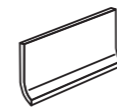

COVE BASE 11,5x30cm 4.6"x12"



INSIDE COVE CORNER 2,5x11,5cm 1"x4.6"



OUTSIDE COVE CORNER 2,5x11,5cm 1"x4.6"

## PACKING AND WEIGHT.

SIZE	THICKNESS	PCS/BOX	SQM/BOX	BOX/PALLET	Kg/BOX	Kg/PALLET	SQMS/PALLET
60x60	10	4	1,44	30	33,20	1016,00	43,20
30x60	10	6	1,08	48	24,24	1183,52	51,84
45x45	10	6	1,215	52	27,42	1445,84	63,18
30x30	9	13	1,17	46	23,66	1108,36	53,82
15x15	-	24	-	-	-	-	-





UNIVERSE .



UNIVERSE .  
BEIGE 60x60cm 24"x24"  
INSERT: MARS/SATURN/JUPITER 5x5cm 2"x2" - SKIRTING BEIGE 8x60cm 3"x24"

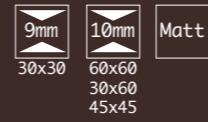

# UNIVERSE.

## SIZES & TRIMS.

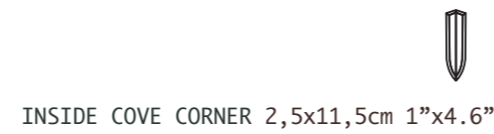
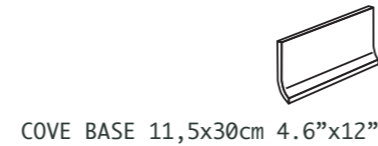
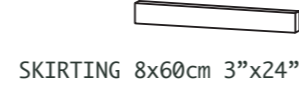
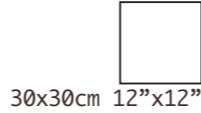
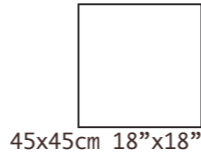
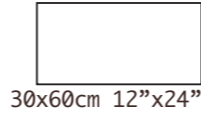
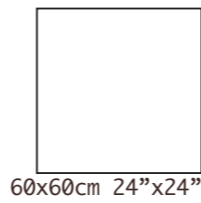

## COLOURS.



## DECORS.

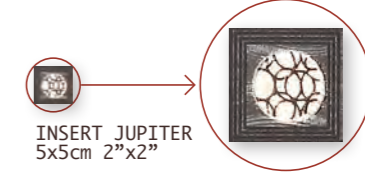
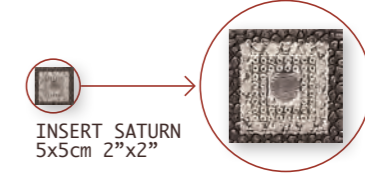
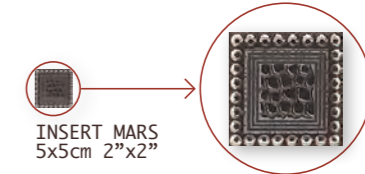

## PACKING AND WEIGHT.

SIZE	THICKNESS	PCS/BOX	SQM/BOX	BOX/PALLET	Kg/BOX	Kg/PALLET	SQMS/PALLET
60x60	10	4	1,44	30	33,20	1016,00	43,20
30x60	10	6	1,08	48	24,24	1183,52	51,84
45x45	10	6	1,215	52	27,42	1445,84	63,18
30x30	9	13	1,17	46	23,66	1108,36	53,82
3,5x30	-	14	-	-	-	-	-
5x5	-	25	-	-	-	-	-

BLACK 60x60cm 24"x24"  
LISTEL PLANET 3,5x30cm 1.4"x12"  
SKIRTING BLACK 8x60cm 3"x24"







WILD.



WILD.  
TAUPE 60x60cm 24"x24"  
MIX ROCK 30x30(5x5)cm 12"x12"(2"x2")  
SKIRTING TAUPE 8x60cm 3"x24"

# WILD.

Lapp

Matt

10mm

## DECORS.



INSERT WOOD.  
30x30cm 12"x12"

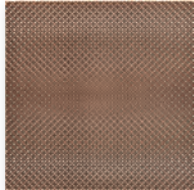

INSET CRYSTAL.  
30x30cm 12"x12"



MIX JUNGLE.  
30x30(5x5)cm  
12"x12"(2"x2")  
CREAM+WENGÉ+INSERT:  
WOOD, CRYSTAL



MIX ROCK.  
30x30(5x5)cm  
12"x12"(2"x2")  
BEIGÉ+TAUPE+INSERT:  
WOOD, CRYSTAL

## MOSAICS ON THE NET.



TAUPE.  
30x30(5x5)cm  
12"x12"(2"x2")



BEIGÉ.  
30x30(5x5)cm  
12"x12"(2"x2")

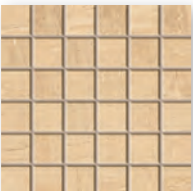

CREAM.  
30x30(5x5)cm  
12"x12"(2"x2")

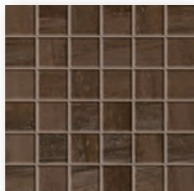

WENGÉ.  
30x30(5x5)cm  
12"x12"(2"x2")

## COLOURS.



TAUPE.



BEIGÉ.



CREAM.



WENGÉ.

## SIZES & TRIMS.



60x60cm 24"x24"



30x60cm 12"x24"



SKIRTING 8x60cm 3"x24"

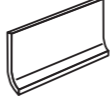

COVE BASE 11,5x30cm 4.6"x12"



INSIDE COVE CORNER 2,5x11,5cm 1"x4.6"



OUTSIDE COVE CORNER 2,5x11,5cm 1"x4.6"

## PACKING AND WEIGHT.

SIZE	THICKNESS	PCS/BOX	SQM/BOX	BOX/PALLET	Kg/BOX	Kg/PALLET	SQMS/PALLET
60x60	10	4	1,44	30	33,20	1016,00	43,20
30x60	10	6	1,08	48	24,24	1183,52	51,84
30x30	9	13	1,17	46	23,66	1108,36	53,82

WENGÉ 60x60cm 24"x24"  
INSERT CRYSTAL 30x30cm 12"x12"





TECHNICAL  
PORCELAIN  
FULL  
BODY



COMPACT.

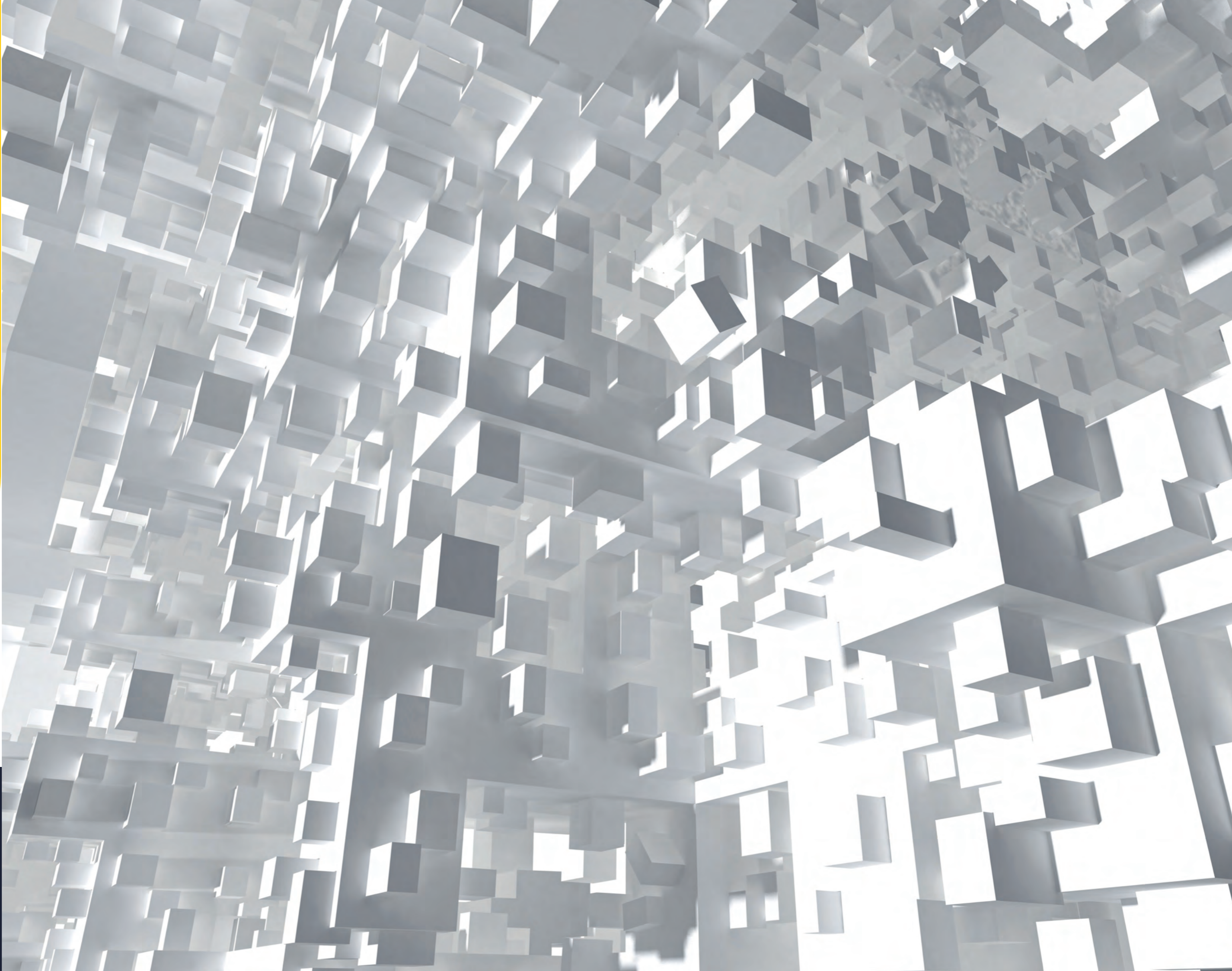



COMPACT .  
BEIGE 40x40cm 16"x16"  
DARK BEIGE 40x40cm 16"x16"

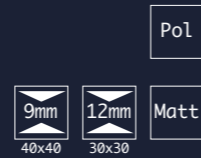

# COMPACT.

## SIZES & TRIMS.

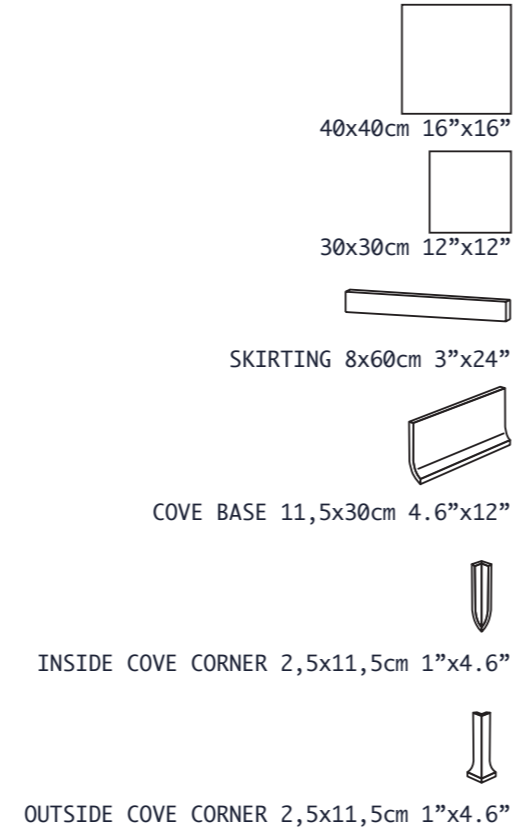

## COLOURS.



## PACKING AND WEIGHT.

SIZE	THICKNESS	PCS/BOX	SQM/BOX	BOX/PALLET	Kg/BOX	Kg/PALLET	SQMS/PALLET
40x40	9	9	1,44	48	29,52	1436,96	69,12
30x30	12	10	0,90	46	24,80	1160,80	41,40





CROMA MALL .





CROMA MALL .  
EXTRA WHITE 60x60cm 24"x24" - NUT 60x60cm 24"x24"  
ROSETTE (EXTRA WHITE-GOLD-SENAPE-NUT-COFFEE-ANTRACITE) ø 403,5cm 161.4"

# DECORS .

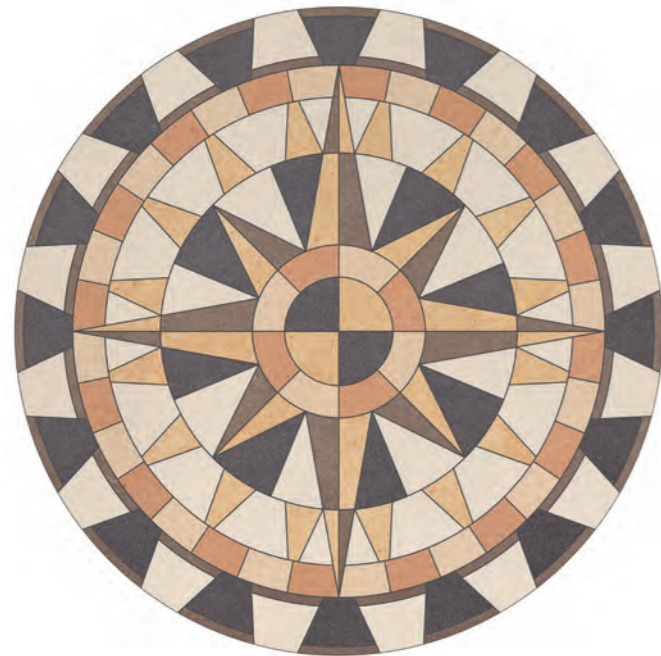

ROSETTE ø 403,5cm 161.4" COMPOSED BY:  
EXTRA WHITE + GOLD + SENAPE + NUT + COFFEE + ANTRACITE  
AVAILABLE IN MANY MEASURES AND SEVERAL COLOR MATCHES,  
RESPONDING TO CUSTOMERS' REQUESTS.

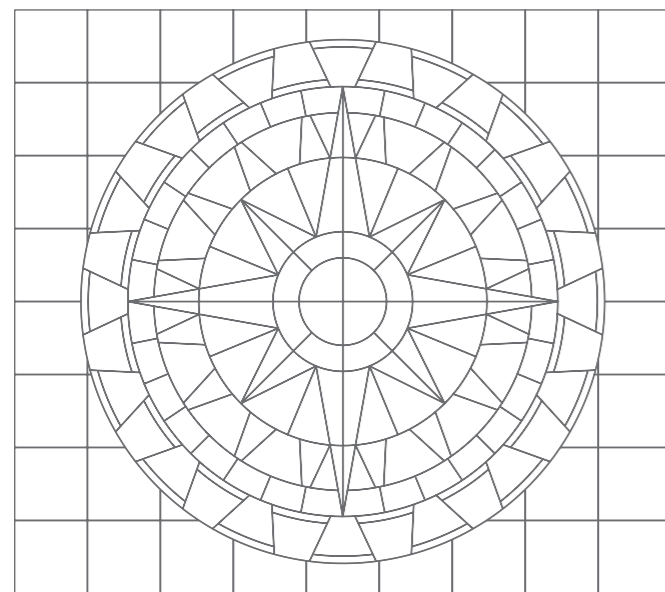

IT IS POSSIBLE, ON DEMAND, TO REALIZE ROSETTES AND DECORS BY  
IDROJET CUT, FOLLOWING THE ORIGINAL CUSTOMERS' PROJECTS.

PoL



# CROMA MALL .

## SIZE & TRIMS .

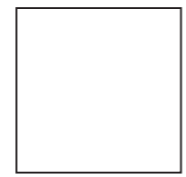

60x60cm 24"x24"



30x60cm 12"x24"



45x45cm 18"x18"



SKIRTING 8x60cm 3"x24"

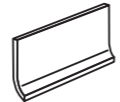

COVE BASE 11,5x30cm 4.6"x12"



INSIDE COVE CORNER 2,5x11,5cm 1"x4.6"



OUTSIDE COVE CORNER 2,5x11,5cm 1"x4.6"

## COLOURS .



WHITE .

GREY .

BEIGE .

SENAPE .



WHITE .

GREY .

BEIGE .

SENAPE .

PoL

## PACKING AND WEIGHT .

SIZE	THICKNESS	PCS/BOX	SQM/BOX	BOX/PALLET	Kg/BOX	Kg/PALLET	SQMS/PALLET
60x60	10	4	1,44	30	33,20	1016,00	43,20
30x60	10	6	1,08	48	24,24	1183,52	51,84
45x45	10	6	1,215	52	27,42	1445,84	63,18



Pol



# CROMA MALL.

## SIZE & TRIMS.

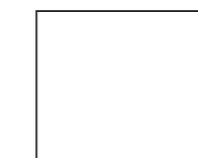

60x60cm 24"x24"

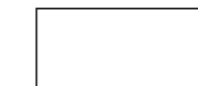

30x60cm 12"x24"

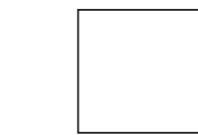

45x45cm 18"x18"



SKIRTING 8x60cm 3"x24"

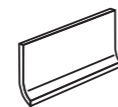

COVE BASE 11,5x30cm 4.6"x12"



INSIDE COVE CORNER  
2,5x11,5cm 1"x4.6"



OUTSIDE COVE CORNER  
2,5x11,5cm 1"x4.6"

## COLOURS.



GOLD.



GOLD.



NUT.



COFFEE.



ANTRACITE.



BLACK.



NUT.



COFFEE.

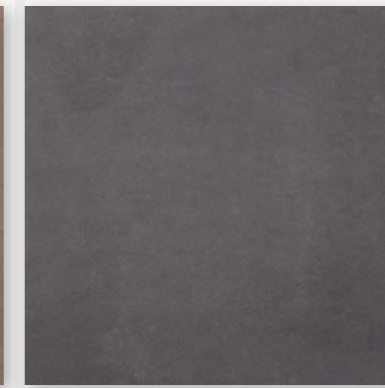

ANTHRACITE.



BLACK.

Pol

## PACKING AND WEIGHT.

SIZE	THICKNESS	PCS/BOX	SQM/BOX	BOX/PALLET	Kg/BOX	Kg/PALLET	SQMS/PALLET
60x60	10	4	1,44	30	33,20	1016,00	43,20
30x60	10	6	1,08	48	24,24	1183,52	51,84
45x45	10	6	1,215	52	27,42	1445,84	63,18





GRANIT .



GRANIT.  
WHITE 30x30cm 12"x12"  
ROSETTE (BLACK-WHITE-COTTO-DARK GREY-BEIGE NEVADA)  
ø 132cm 52.8"

# GRANIT.

Po1 8mm

Matt 9mm

## DECORS.

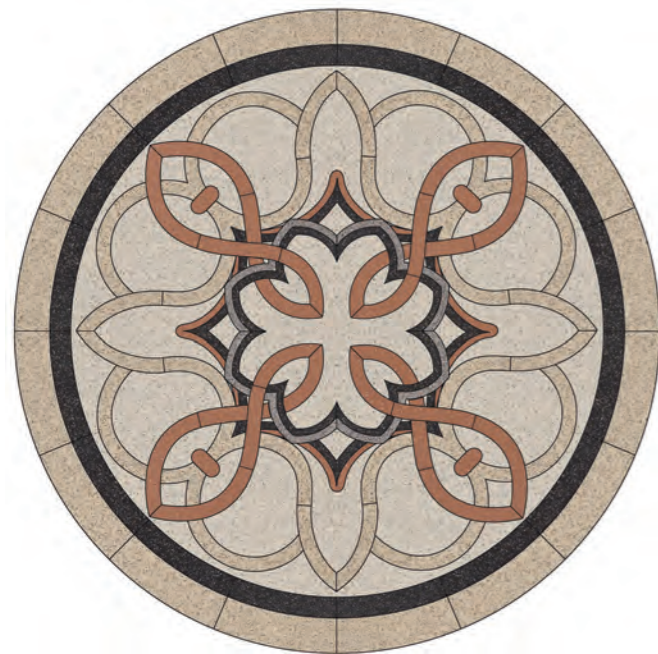

ROSETTE ø 132cm 52.8" COMPOSED BY:  
BLACK+WHITE+COTTO+DARK GREY+BEIGE NEVADA

AVAILABLE IN MANY MEASURES AND SEVERAL COLOR MATCHES, RESPONDING TO CUSTOMERS' REQUESTS.

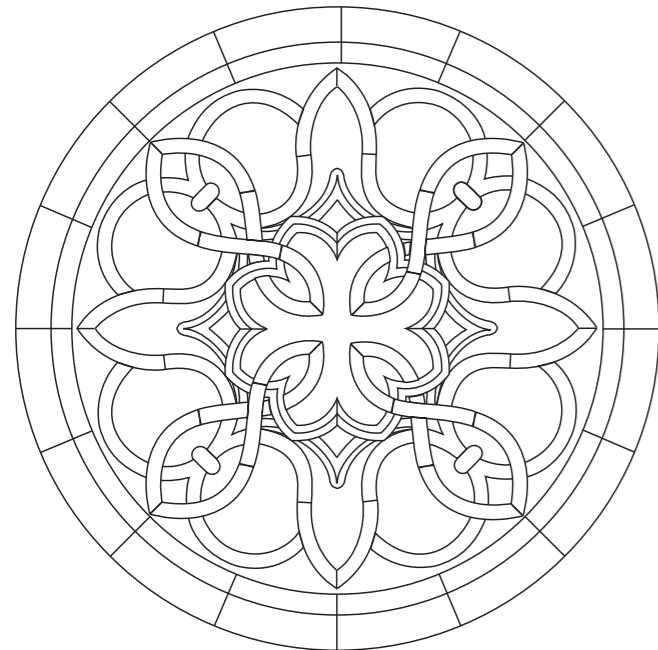

IT IS POSSIBLE, ON DEMAND, TO REALIZE ROSETTES AND DECORS BY IDROJET CUT, FOLLOWING THE ORIGINAL CUSTOMERS' PROJECTS.

## COLOURS.



## SIZES & TRIMS.

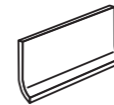
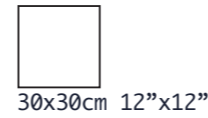

## PACKING AND WEIGHT.

SIZE	THICKNESS	PCS/BOX	SQM/BOX	BOX/PALLET	Kg/BOX	Kg/PALLET	SQMS/PALLET
30x30	9	13	1,17	46	23,66	1108,36	53,82

WHITE-BEIGE NEVADA-COTTO  
30x30cm 12"x12"



# GRANIT.



WHITE-GREY-DARK GREY-BLACK  
30x30cm 12"x12"

## COLOURS.



## SIZES & TRIMS.

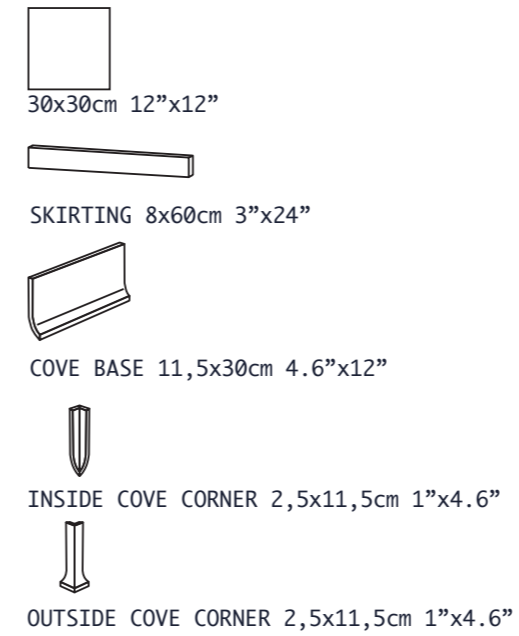

## PACKING AND WEIGHT.

SIZE	THICKNESS	PCS/BOX	SQM/BOX	BOX/PALLET	Kg/BOX	Kg/PALLET	SQMS/PALLET
30x30	9	13	1,17	46	23,66	1108,36	53,82



LEGEND.

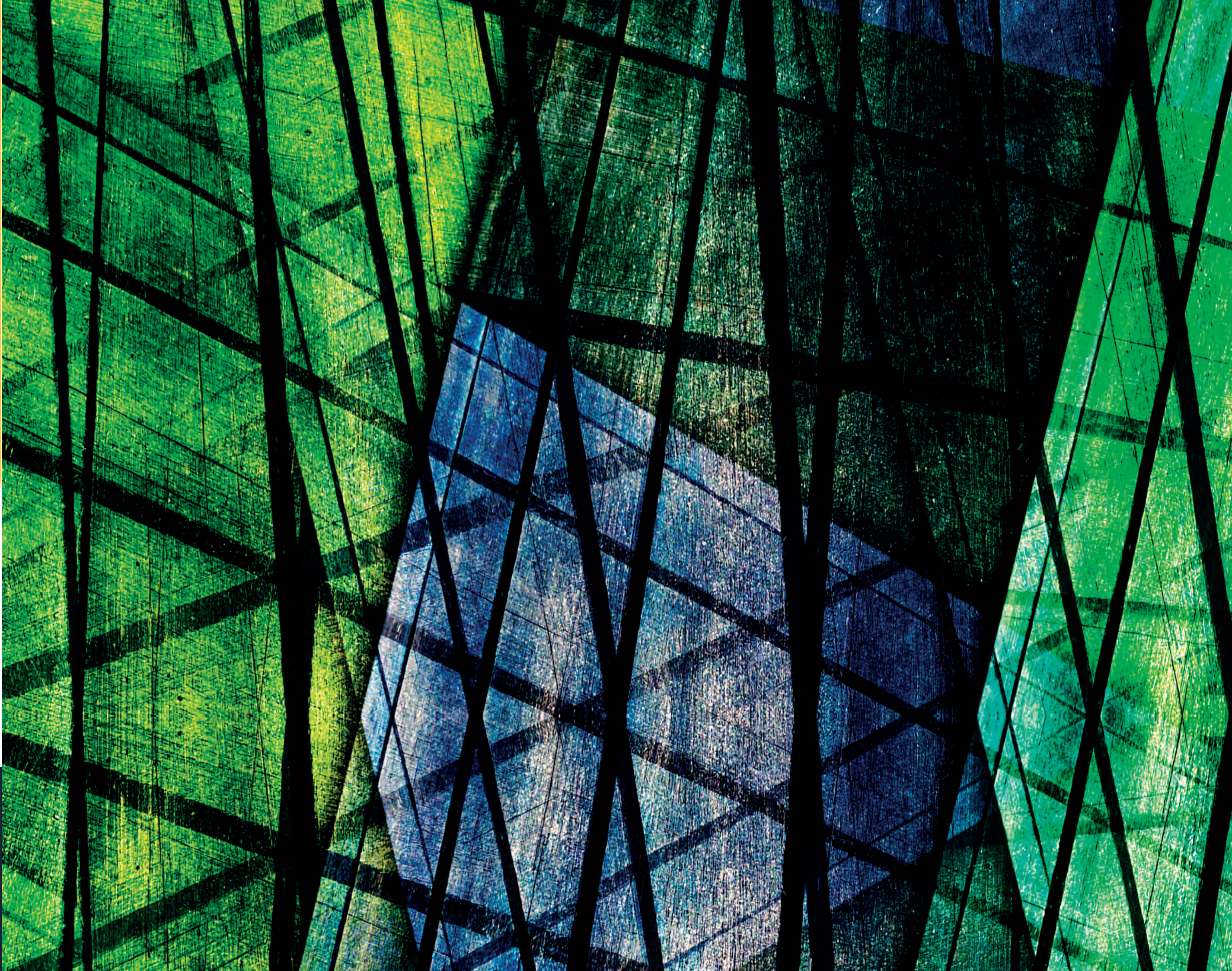





LEGEND.

WHITE 60x60cm 24"x24" - BLACK 60x60cm 24"x24"  
ROSETTE (PINK-CREAM-WHITE-GREY) ø132cm 52.8"

# DECORS.

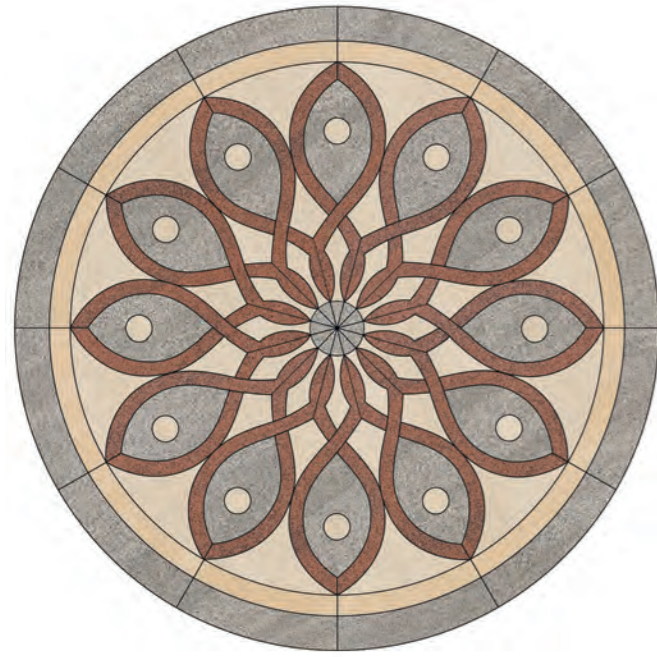

ROSETTE ø 132cm 52.8" COMPOSED BY:  
PINK + CREAM + WHITE + GREY

AVAILABLE IN MANY MEASURES AND SEVERAL COLOR MATCHES, RESPONDING TO COSTUMERS' REQUESTS.

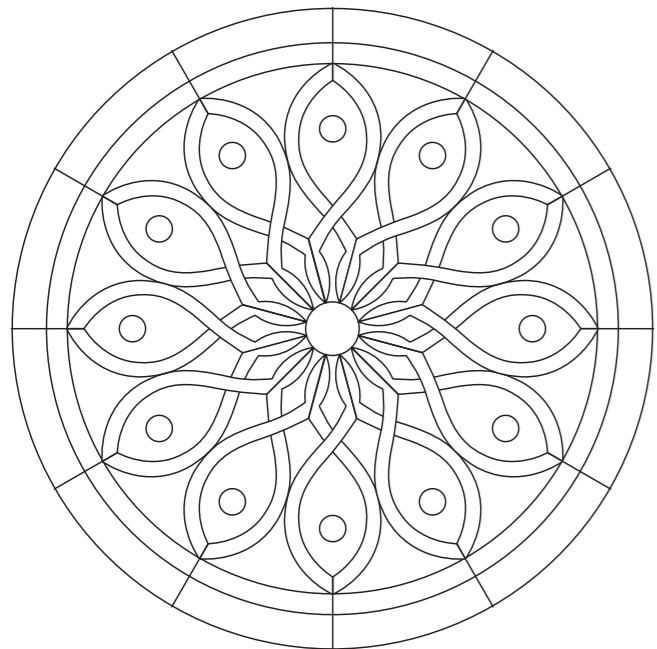

IT IS POSSIBLE, ON DEMAND, TO REALIZE ROSETTES AND DECORS BY IDROJET CUT, FOLLOWING THE ORIGINAL COSTUMERS' PROJECTS.



# LEGEND.

## SIZES & TRIMS.

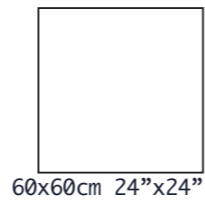

60x60cm 24"x24"

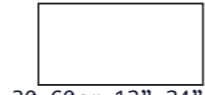

30x60cm 12"x24"



SKIRTING 8x60cm 3"x24"

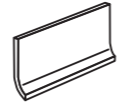

COVE BASE 11,5x30cm 4.6"x12"



INSIDE COVE CORNER 2,5x11,5cm 1"x4.6"



OUTSIDE COVE CORNER 2,5x11,5cm 1"x4.6"

## COLOURS.

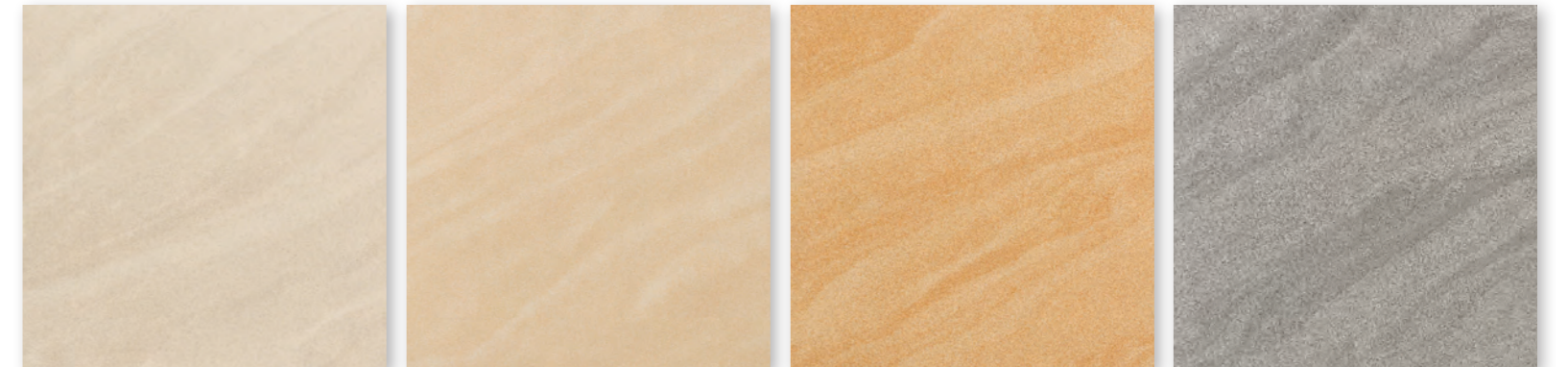

WHITE.

CREAM.

GOLD.

GREY.

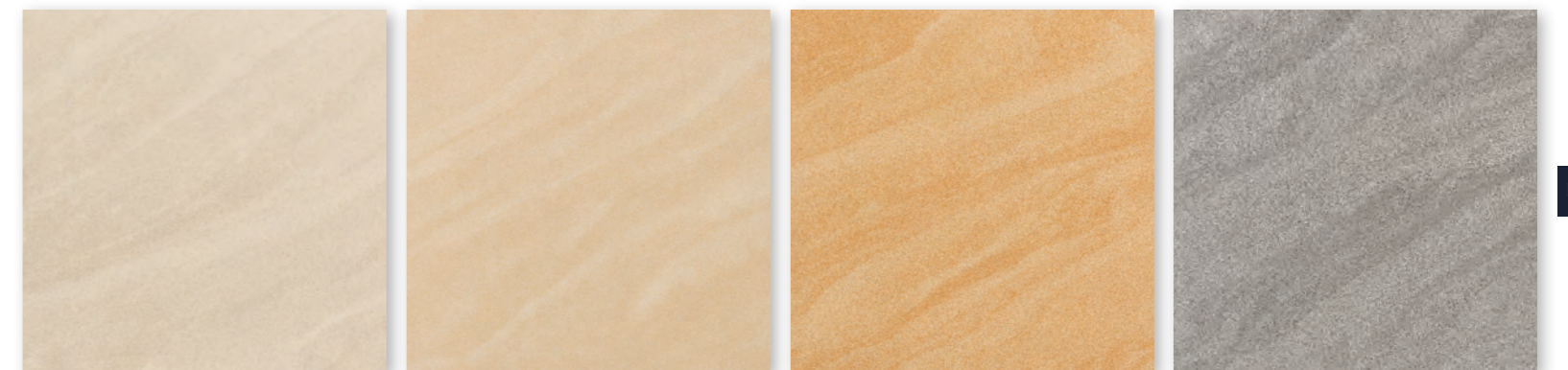

WHITE.

CREAM.

GOLD.

GREY.

Pol

## PACKING AND WEIGHT.

SIZE	THICKNESS	PCS/BOX	SQM/BOX	BOX/PALLET	Kg/BOX	Kg/PALLET	SQMS/PALLET
60x60	10	4	1,44	30	33,20	1016,00	43,20
30x60	10	6	1,08	48	24,24	1183,52	51,84





# LEGEND.

## SIZES & TRIMS.



60x60cm 24"x24"



30x60cm 12"x24"



SKIRTING 8x60cm 3"x24"

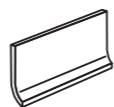

COVE BASE 11,5x30cm 4.6"x12"



INSIDE COVE CORNER 2,5x11,5cm 1"x4.6"



OUTSIDE COVE CORNER 2,5x11,5cm 1"x4.6"

## COLOURS.

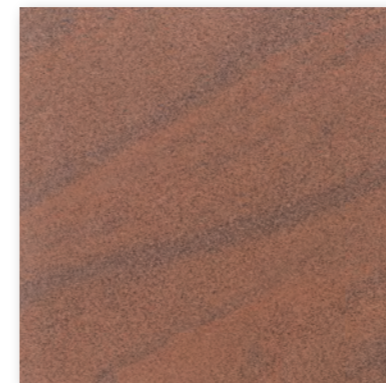

PINK.



CHOCOLATE.



BLACK.

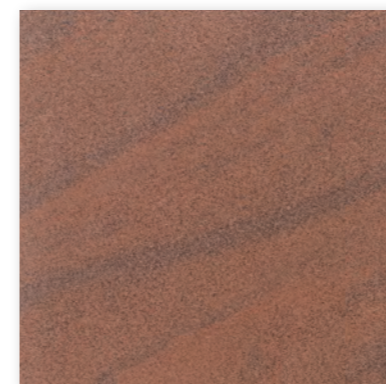

PINK.



CHOCOLATE.



BLACK.

Pol

WHITE-GOLD-CHOCOLATE  
60x60cm 24"x24"

## PACKING AND WEIGHT.

SIZE	THICKNESS	PCS/BOX	SQM/BOX	BOX/PALLET	Kg/BOX	Kg/PALLET	SQMS/PALLET
60x60	10	4	1,44	30	33,20	1016,00	43,20
30x60	10	6	1,08	48	24,24	1183,52	51,84

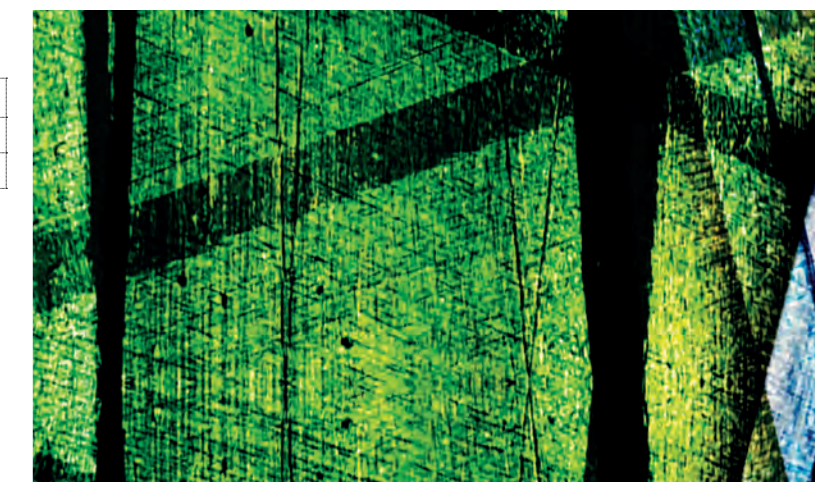



قسم الفرز والتغليف  
SORTING AND PACKAGING DEPARTMENT

QUALITY CERTIFICATES

# CERTIFICATE OF REGISTRATION

# CERTIFIED TESTS - PORCELAIN



**MS CERT**

## Certificate Of Registration

### QUALITY MANAGEMENT SYSTEM

This is to Certify that the Quality Management System of:  
**FUTURE CERAMICS**

Address: **11372, RIYADH, Saudi Arabia**

ANZSIC CODE: 2622

Has been assessed and found to meet the requirements of:

# ISO 9001:2008

The certificate is valid for the following scope:  
**Logistics, Ceramic And Porcelain Manufacturing**  
Certificate Number: EG/QMS/00025  
Issue no.: 01

Date of approval : 29.09.2012      Valid until : 28.09.2015  
Revision no: nil      Revision date : nil

  
**Managing Director**

  
Supervision Audit 2nd Year





ACC No: M41210018

**MS CERTIFICATION SERVICES PVT. LTD.**  
www.ms-certification.org

The Accreditation Body is Joint Accreditation System of Australia and New Zealand (JAS-ANZ)  
Level 1, Members Equity Bank Building, 11 London Circuit, Canberra, ACT 2600  
The validity of this certificate can be verified at [www.jas-anz.org/register](http://www.jas-anz.org/register)  
The Certificate is Valid Only if the Annual Surveillance Mark is Signed by Auditor on Original.  
F06 rev 03

Exova (Saudi Arabia) Co. Ltd. T: +966 3 812 7781  
PO Box 31775 F: +966 3 812 1857  
Al Khobar 31952 E: [saudi@exova.com](mailto:saudi@exova.com)  
Kingdom of Saudi Arabia W: [www.exova.com](http://www.exova.com)



### PORCELAIN TILE TECHNICAL DATA SHEET

#### BS EN 14411

Client:	Future Ceramics	Date Received:	17-Mar-12
Project Name:	Internal Quality Check	Date Tested:	24-Mar-12
Tested by:	WG	Date Reported:	17-Apr-12
Sample Description:	Granit Dove Porcelain Tile	Exova Sample No.:	C12/0011-1
Glazed/Unglazed:	Unglazed	Lab Request No.:	SA/C12/1126
Size of sample:	300 X 300 mm	Report No.:	KSA/12/0404-0410
Sampling Method:	Random	Clients Reference:	ADR/QTH/0052/12
Tile Group	B3a	Sample Reference:	N/A

Description	Test Standard	Measurement Unit	BS EN 14411 Requirement	Test Result
<b>DIMENSION &amp; SURFACE QUALITY</b>				
Length	BS EN ISO 10545-2	mm	± 0.5%	0%
Width	BS EN ISO 10545-2	mm	± 0.5%	0%
Thickness	BS EN ISO 10545-2	mm	± 0.5%	0.24%
Rectangularity	BS EN ISO 10545-2	mm	± 0.5%	0.02%
Surface Flatness	BS EN ISO 10545-2	mm	± 0.5%	0.02%
(a) Centre Curvature	BS EN ISO 10545-2	mm	± 0.5%	0.01%
(b) Edge Curvature	BS EN ISO 10545-2	mm	± 0.5%	0.05%
(c) Warpage	BS EN ISO 10545-2	mm	± 0.5%	0%
Surface Quality	BS EN ISO 10545-2	mm	95% min	95%
<b>PRODUCT QUALITY &amp; DURABILITY</b>				
Water Absorption	BS EN ISO 10545-2	%	≤ 0.5%	0.01%
Breaking Strength	BS EN ISO 10545-4	N	≥ 1400 N	1707 N
Modulus of Rupture	BS EN ISO 10545-4	N/mm <sup>2</sup>	≥ 35 N/mm <sup>2</sup>	66 N/mm <sup>2</sup>
<b>CHEMICAL RESISTANCE</b>				
Resistance to Ammonium Chloride	BS EN ISO 10545-13	Class	AA/AB/BC	AA
Resistance to Low (L) Concentrations of Acids & Alkalis	BS EN ISO 10545-13	Class	AAA/BB/BC	AAA
Resistance to High (H) Concentrations of Acids & Alkalis	BS EN ISO 10545-13	Class	AAA/BB/BC	AAA
<b>RESISTANCE TO STAINS</b>				
Green Staining Agents in Light Dose	BS EN ISO 10545-14	Class	5	5
Yellow	BS EN ISO 10545-14	Class	5	5
Other D1	BS EN ISO 10545-14	Class	5	5

**Client Information:**

Future Ceramics  
Dammam Second Industrial Area  
P.O. Box 2357, Dammam 34327  
Tel: +966 3 812 3624  
Fax: +966 3 812 3100

**For and on-behalf of Exova (Saudi Arabia) Co. Ltd.**

  
**Adrian Pettit**  
 Competence Manager  
 Exova (Saudi Arabia) Co. Ltd.  
 Laboratory Manager - Civils

Tested by: WG      Exova Logo      3071      KSA/12/0404-0410

Exova (Saudi Arabia) Co. Ltd. PO Box 31775, Al Khobar 31952, Kingdom of Saudi Arabia. Tel: +966 3 812 7781. Fax: +966 3 812 1857

The Certificate is only valid if signed by the Auditor. Any other signature is invalid. Any other signature is invalid if the validity period has expired. The validity of this certificate can be verified at [www.jas-anz.org/register](http://www.jas-anz.org/register). The Certificate is Valid Only if the Annual Surveillance Mark is Signed by Auditor on Original. F06 rev 03



**CENTRO CERAMICO**  
CENTRO DI RICERCA E  
SPERIMENTAZIONE PER L'INDUSTRIA  
CERAMICA

**SEDE**  
Via Martelli, 26 - 40136 Bologna  
Tel. (051) 534018 - Fax (051) 530085

**CERTI.CER.**  
LABORATORIO DI ZONA  
Via Valle d'Aosta, 1 - 41049 Sassuolo  
Tel. e Fax (0536) 802154  
Part. IVA 0064776-0375



LAB N° 0058  
SIGNATORY of EA, IAF and ILAC  
Mutual Recognition Agreements

Bologna, 11/07/11

Spett.le  
FUTURE CERAMICS  
P O Box 2367  
Dammam 34327/7351  
KINGDOM of SAUDI ARABIA (KSA)

**TEST LABORATORY**

**TEST REPORT No. 3893/11**

concerning ceramic tiles according to EN 14411:2006

Requested by: FUTURE CERAMICS  
P O Box 2367  
Dammam 34327/7351  
KINGDOM of SAUDI ARABIA (KSA)

On (date): 10/04/11

For the sample marked:  
"COCOA HALL BEIGE"

The results reported relate only to the samples tested.  
No responsibility is taken for the accuracy of the sampling unless it is done under our own supervision.  
The reproduction of this test report is only authorized in the form of a complete photographic facsimile. Our written approval is necessary for any partial reproduction.  
This test report consists of 3 pages this cover included.

 Ministero delle Attività Produttive  

 Ministero dell'Industria  

 Ministero della Ricerca Scientifica  

 Ministero dell'Università e della Ricerca  

 Ministero della Cultura  

 Ministero della Sanità  

 Ministero dell'Ambiente  

 Ministero delle Infrastrutture e dei Trasporti  

 Ministero delle Risorse Idriche  

 Ministero delle Politiche Agricole, Alimentari e Rurali

CERLABS EUROPEAN NETWORK OF NATIONAL CERAMIC LABORATORIES - ITALIAN MEMBER



**CENTRO CERAMICO - BOLOGNA**

Page 1 of 3

Test Report No. 3893/11 Date 11/07/11

Description of the sample:  
Un glazed ceramic tiles 60,95 x 60,95 x 10,02 mm  
marked "COCOA HALL BEIGE".

Manufacturer: -----

Sampling details:  
- Where: -----  
- Date: -----  
- By whom: CUSTOMER  
- How (methods): -----

DATE OF RECEIVAL IN LABORATORY: 04/05/11

TEST PERFORMED:

	Date of starting	Date of ending
<input checked="" type="checkbox"/> EN ISO 10545 - 3 : 1997 Determination of water absorption, apparent porosity, apparent relative density and bulk density	20/05/11	24/05/11

 Ministero delle Attività Produttive  

 Ministero dell'Industria  

 Ministero della Ricerca Scientifica  

 Ministero dell'Università e della Ricerca  

 Ministero della Cultura  

 Ministero della Sanità  

 Ministero dell'Ambiente  

 Ministero delle Infrastrutture e dei Trasporti  

 Ministero delle Risorse Idriche  

 Ministero delle Politiche Agricole, Alimentari e Rurali

**ACCREDIA** CENTRO CERAMICO - BOLOGNA

LAB N° 0058  
 Test Report No. 3887/11 Date 11/07/11 Page 3 of 3

**EN ISO 10545-3 : 1997- Determination of water absorption, apparent porosity, apparent relative density and bulk density**

**6.1 - BOILING METHOD**

Water absorption (%) of each tiles:

Sample	1	2	3	4	5
E(b)	0.1	0.0	0.0	0.1	0.1

E(b) Average (%): 0.1

Prof. Eng. Giorgio Timellini  
 DIRECTOR



**CENTRO CERAMICO** **ACCREDIA**

LAB N° 0058 Bologna, 11/07/11

CENTRO DI RICERCA E SPERIMENTAZIONE PER L'INDUSTRIA CERAMICA  
 SEDE: Via Martelli, 26 - 40138 Bologna  
 Tel. (051) 634915 - Fax (051) 530085  
 CERTI.CER. LABORATORIO DI ZONA  
 Via Valle d'Asola, 1 - 41049 Sassuolo  
 Tel. e Fax: (0535) 802154  
 Part. IVA 00847780375

Spett.le  
 FUTURE CERAMICS  
 P.O. Box 2367  
 Dammam 343277351  
 KINGDOM of SAUDI ARABIA (KSA)

**TEST LABORATORY**  
**TEST REPORT No. 3887/11**  
 concerning ceramic tiles according to EN 14411:2006

Requested by: FUTURE CERAMICS  
 P.O. Box 2367  
 Dammam 343277351  
 KINGDOM of SAUDI ARABIA (KSA)

On (date): 11/07/11

For the sample marked:  
 "QUARZITE LIGHT GREY".

The results reported relate only to the samples tested.  
 No responsibility is taken for the accuracy of the sampling unless it is done under our own supervision.  
 The reproduction of this test report is only authorized in the form of a complete photographic facsimile. Our written approval is necessary for any partial reproduction.  
 This test report consists of 3 pages this cover included.

**CERLABS - EUROPEAN NETWORK OF NATIONAL CERAMIC LABORATORIES - ITALIAN MEMBER**

**ACCREDIA** CENTRO CERAMICO - BOLOGNA

LAB N° 0004  
 Test Report No. 3887/11 Date 11/07/11 Page 2 of 3

**Description of the sample**  
 Glazed ceramic tiles 45,5 x 45,5 x 0,99 cm max  
 "QUARZITE LIGHT GREY",  
 Manufacturer: \_\_\_\_\_

**Sampling details:**  
 - Where: \_\_\_\_\_  
 - Date: \_\_\_\_\_  
 - By whom: EDGEMER  
 - How (methods): \_\_\_\_\_

DATE OF RECEIVAL IN LABORATORY: 04/05/11

**TEST PERFORMED:**

	Date of starting	Date of ending
<input checked="" type="checkbox"/> EN ISO 10545 - 12:1997 Determination of frost resistance	20/05/11	27/06/11

**ACCREDIA** CENTRO CERAMICO - BOLOGNA

LAB N° 0004  
 Test Report No. 3887/11 Date 11/07/11 Page 2 of 3

**EN ISO 10545 - 12:1997 - Determination of frost resistance.**

Number of tiles in the test sample: 10

Water content before the freeze-thaw test: 0.3

Water content after the freeze-thaw test: 0.1

Description of defects before the test: \_\_\_\_\_

Damages on the glaze or proper surface and the edges of tiles after the freeze-thaw test: \_\_\_\_\_

Number of damaged tiles after 100 cycles from -5° C to +5° C: 0

 Prof. Eng. Giorgio Timellini  
 DIRECTOR





**ACCREDIA** CENTRO CERAMICO - BOLOGNA

LAB N° 0056  
 Test Report No. 3912/11 Date 11/07/11 Page 2 of 1

**ISO 10545-14 : 1997 - Determination of stain resistance**

Test solutions	RESISTANCE CLASS				
	Sample 1	Sample 2	Sample 3	Sample 4	Sample 5
Stains					
Chrome green in light oil	5	5	5	5	5
Iodine (alcoholic solution 13g/l)	5	5	5	5	5
Olive oil (def. Olive Oil Agreement - 1979)	5	5	5	5	5

Stain resistance class - References  
 Resistance class 1: Stain not removed.  
 Resistance class 2: Stain removed by dipping in a suitable solvent for 24 hours.  
 Resistance class 3: Stain removed by mechanical cleaning and strong cleansing agent.  
 Resistance class 4: Stain removed by manual cleaning with weak cleansing agent.  
 Resistance class 5: Stain removed by means of hot current water for 5 min.

*[Handwritten Signature]*

Prof. Eng. Giorgio Tamellini  
 DIRECTOR

Mod. EN ISO 14 UK 160210

**CENTRO CERAMICO** **ACCREDIA**

CENTRO DI RICERCA E SPERIMENTAZIONE PER L'INDUSTRIA CERAMICA  
 SEDE: Via Marconi, 26 - 40138 Bologna  
 Tel. (051) 534015 - Fax. (051) 530065

CERTI.CER. LABORATORIO DI ZONA  
 Via Valle d'Aosta, 1 - 41040 Sassuolo  
 Tel. e Fax. (0536) 802154  
 Part. IVA 0094778-0375

LAB N° 0056 Bologna 11/07/11  
 Laboratory of EA, IAF and ILAC Mutual Recognition Agreements

Spett.le FUTURE CERAMICS  
 P.O. Box 2367  
 Dammam 34327/7351  
 KINGDOM of SAUDI ARABIA (KSA)

**TEST LABORATORY**  
**TEST REPORT No. 3912/11**  
 concerning ceramic tiles according to EN 14411:2006

Requested by: FUTURE CERAMICS  
 P.O. Box 2367  
 Dammam 34327/7351  
 KINGDOM of SAUDI ARABIA (KSA)

On (date): 11/07/11

For the sample marked: "FUTURE CERAMICS"

The results reported relate only to the samples tested.  
 No responsibility is taken for the accuracy of the sampling unless it is done under our own supervision.  
 The reproduction of this test report is only authorized in the form of a complete photographic facsimile. Our written approval is necessary for any partial reproduction.  
 This test report consists of 3 pages this cover included.

**CERLABS EUROPEAN NETWORK OF NATIONAL CERAMIC LABORATORIES - ITALIAN MEMBER**

# Technical Specifications

## Test Floor Tiles B11a

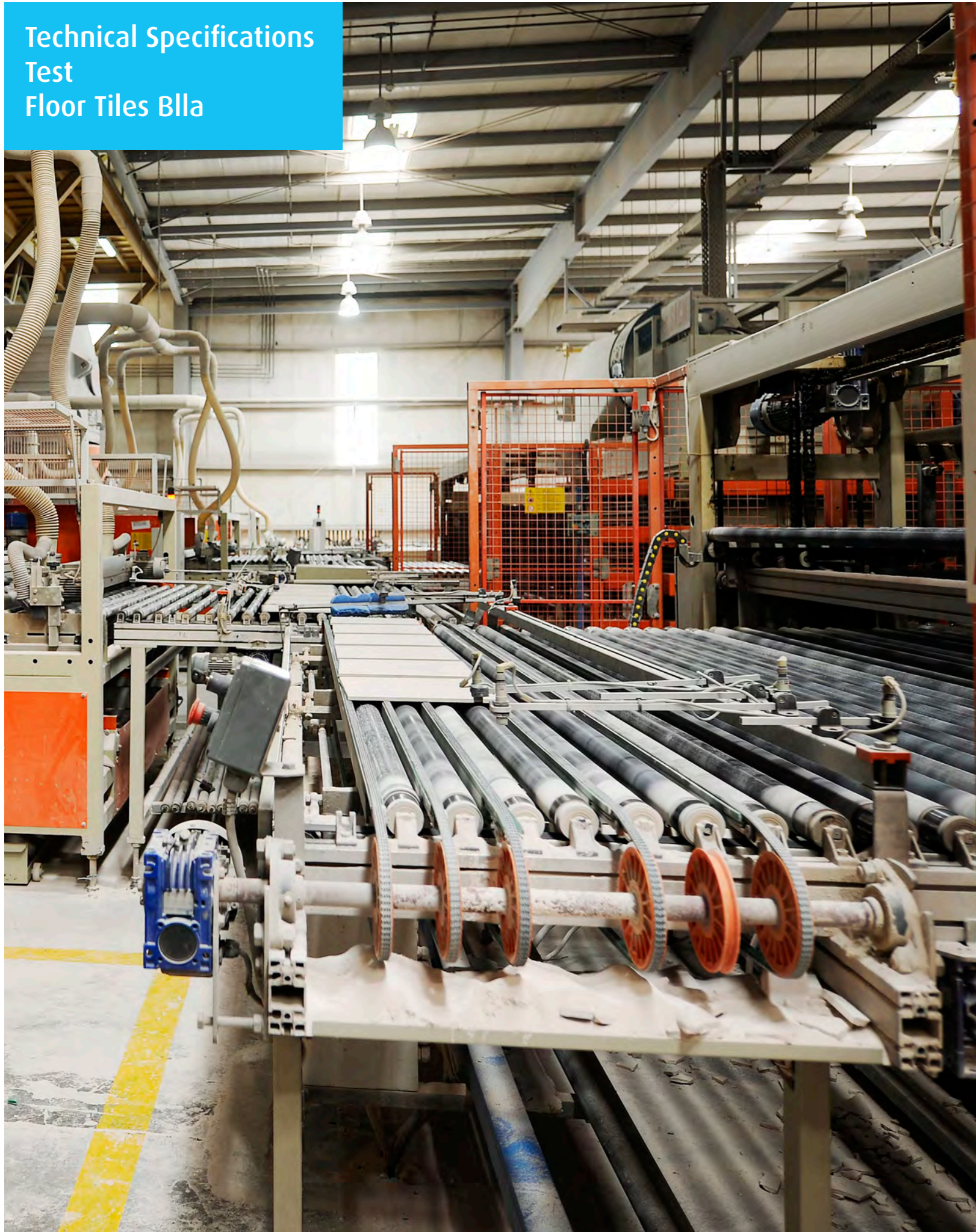

Test Discription	Test Metod	Semi Vitrified	Future Ceramics
Length And Width	BS EN ISO 10545-2	0.5%	conform
	SSA 1030"	0.30%	conform
Thickness	BS EN ISO 10545-2	5.0%	conform
	SSA 1030	5.0%	conform
Rectangular Squareness	BS EN ISO 10545-2	0.40%	conform
	ASTM C502 SSA 1030	0.50%	
Straightness of Sides	BS EN ISO 10545-2	0.40%	conform
	SSA 1030	0.40%	conform
Surfaces Flatness	BS EN ISO 10545-2 ASTM C485 SSA 1030	0.40%	conform
Water Absoption	BS EN ISO 10545-3 ASTM C373 SSA 1030	3 ≤ % ≤ 6	conform
Modulus Of Rupture : N/MM3	BS EN ISO 10545-4 SSA 1030	≥ 25	conform
Breaking Strength: KG.Tickness > 7.5MM	BS EN ISO 10545-4 SSA 1030	> 1100	conform
Resistance to Surface Abrasion	BS EN ISO 10545-7 SSA 1030	Class 2-5	conform
Hardness Moh's Scale	EN 101	> 5	conform
	SSA 1030	> 5	conform
Thermal Shock Resistance	BS EN ISO 10545-9 ASTM C484 SSA 1030	no damage	conform
Crazing Resistance	BS EN ISO 10545-11	no crazing	conform
	SSA 1030	no crazing	conform
Resistance to Chemicals	BS EN ISO 10545-13 ASTM C650 SSA 1030	no damage	conform
Resistance to Stains	BS EN ISO 10545-14	Stains remov	conform
	SSA 1030	Stains remov	conform
Color Resistance to UV Light	DIN 51094	No Change	conform
Resistance to Frost	BS EN ISO 10545-12	no required	conform
Resistance of Freeze	ASTM C 1026-87	Resistant	Resistant

# Technical Specifications Test Wall Tiles B

C B009/A  
DB-3



Test Discription	Test Metod	Semi Vitrified	Future Ceramics
Length And Width	BS EN ISO 10545-2	0.5%	conform
	SSA 1030	0.30%	conform
Thickness	BS EN ISO 10545-2	5.0%	conform
	SSA 1030	5.0%	conform
Rectangular Squareness	BS EN ISO 10545-2	0.40%	conform
	ASTM C502 SSA 1030	0.50%	conform
Straightness of Sides	BS EN ISO 10545-2	0.30%	conform
	SSA 1030	0.30%	conform
Surfaces Flatness	BS EN ISO 10545-2	0.30%	conform
	ASTM C485 SSA 1030	0.30%	conform
Water Absoptioin	BS EN ISO 10545-3	> 10%	conform
	ASTM C373 SSA 1030	10%	conform
Modulus Of Rupture : N/MM3	BS EN ISO 10545-4	> 18	conform
	SSA 1030	> 12	conform
Breaking Strength:KG.Tickness > 7.5MM	BS EN ISO 10545-4	> 700	conform
	SSA 1030		conform
Resistance to Surface Abrasion	BS EN ISO 10545-7	Class 2-4	conform
	SSA 1030	Class 2-4	conform
Hardness Moh's Scale	EN 101	> 3	conform
	SSA 1030	> 3	conform
Thermal Shock Resistance	BS EN ISO 10545-9	no damage	conform
	ASTM C484 SSA 1030	no damage	conform
Crazing Resistance	BS EN ISO 10545-11	no crazing	conform
	SSA 1030	no crazing	conform
Resistance to Chemicals	BS EN ISO 10545-13	no damage	conform
	ASTM C650 SSA 1030	no damage	conform
Resistance to Stains	BS EN ISO 10545-14	Stains remov	conform
	SSA 1030	Stains remov	conform
Color Resistance to UV Light	DIN 51094	No Change	conform
Resistance to Frost	BS EN ISO 10545-12	no required	conform
Resistance of Freeze	ASTM C 1026-87	Resistant	Resistant

## Technical Specifications Glazed Porcelain Stoneware Group B1a



	Test Discription	Norms	Requird Standers	Future Ceramics Values
Regularity characteristic	Length And Width	BS EN ISO 10545-2	+0.5%	conform
	Thickness	BS EN ISO 10545-2	+5%	conform
	Straightness of sides	BS EN ISO 10545-2	+0.5%	conform
	Rectangularity	BS EN ISO 10545-2 ASTM C502	+0.6%	conform
	Surfaces Flatness	BS EN ISO 10545-2 ASTM C485	±0.5%	±0.35%
Structural characteristic	Water Absoption	BS EN ISO 10545-3 ASTM C373	<0.5%	≤ 0.2%
Bulk mechanical characteristic	Breaking Strength	BS EN ISO 10545-4	S>1300N	S>2300N
	Modulus Of Rupture	BS EN ISO 10545-4	R≥35N/mm2	R<42N/mm2
Surface mechanical characteristic	Resistance to Surface Abrasion	"BS EN ISO 10545-7	Class 2-5	conform
	Moh's Hardness (Scratch)	SSA 1031	>5	>9
Thermal and hygremetric characteristic	Coefficient Of Thermal Linea Expansion	BS EN ISO 10545-8	< 9 MK	6.9 MK
	Thermal Shock Resistance	SSA 1031 ASTM C484	Test Available	Resistant
	Resistance to Frost	BS EN ISO 10545-12	Required	Resistant
Safety characteristic	Dynamic Friction Coefficient	BRCA	DRY u > 0.40	DRY u > 0.53
	Static Coefficient Of Friction	ASTM C 1028-2007	Slip Resistant >0.60	"0.98 Dry 0.63 wet"
	Non-slip Classification	Din 51130	Ramps Test	R=10
Chemical characteristic	Resistance to Household Chemicals And Swimming Pool Salts	BS EN ISO 10545-13 ASTM C650	Class UB min	GA
	Resistance to Low Concentration of Acid And Alkalis	BS EN ISO 10545-13 ASTM C650	Manufacturer To State Classification	GLA
	Resistance to Low Concentration of Acid And Alkalis	BS EN ISO 10545-13 ASTM C650	Test Available	GHA
	Color Resistance to UV Light	DIN 51094	No Change	No Change
	Resistance to Staining	BS EN ISO 10545-14	No evident Variation	Non Evident
	Lead and Cadumium Leaching	BS EN ISO 10545-15:2000	Lead 0.00 Cadmium0.00	"0.00 0.00"
	Determination of Small Color Differences	BS EN ISO 10545-16	E<1	0.75
Fisical characteristic	Mousture Expansion	ISO 10545-10	Mm/m	0.03
	Resistance of Freeze	ASTM C 1026-87	Resistant	Resistant
	Shock Resistant	ISO 10545-5	Resistant	Resistant
Qualtiy surface	Determination Surface Quality	SSA 1031/1998	Without Defict 95%	conform

**Technical Specifications**  
**Technical Porcelain Full Body**  
**Group B1a**



	Test Discription	Norms	Requird Standerds	Future Ceramics Values
Regularity characteristic	Length And Width	BS EN ISO 10545-2	+0.5%	conform
	Thickness	BS EN ISO 10545-2	+5%	conform
	Straightness of sides	BS EN ISO 10545-2	+0.5%	conform
	Rectangularity	BS EN ISO 10545-2 ASTM C502	+0.6%	conform
	Surfaces Flatness	BS EN ISO 10545-2 ASTM C485	0.5%	0.35%
Structural characteristic	Water Absoption	BS EN ISO 10545-3 ASTM C373	<0.1%	≤ 0.05%
Bulk mechanical characteristic	Breaking Strength	BS EN ISO 10545-4	S>1300N	S>2300N
	Modulus Of Rupture	BS EN ISO 10545-4	R≥35N/mm²	conform
Surface mechanical characteristic	Resistance to Deep Abrasion	BS EN ISO10545-6 ASTMC-501	≤175mm³ lw≥100	<123mm³ >190
	Moh's Hardness (Scratch)	SSA 1031	> 6	6
Thermal and hygremetric characteristic	Coefficient Of Thermal Linea Expansion	BS EN ISO 10545-8	< 9 MK	7.3 MK
	Thermal Shock Resistance	SSA 1031 ASTM C484 BS EN ISO 10545-9	Test Available	Resistant
	Resistance to Frost	BS EN ISO 10545-12 SAA 1031	Required	conform
Safety characteristic	Dynamic Friction Coefficient	BRCA	DRY u > 0.40	u>0.53
	Static Coefficient Of Friction	ASTM C 1028-2007	Slip Resistant >0.60	"1.0 Dry 0.97 wet"
	Non-slip Classification	Din 51130	Ramps Test	R=10
Chemical characteristic	Resistance to Household Chemicals And Swimming Pool Salts	BS EN ISO 10545-13 ASTM C650	Class UB min	UA
	Resistance to Low Concentration of Acid And Alkalis	BS EN ISO 10545-13 ASTM C650	Manufacturer To State Classification	ULA
	Resistance to Low Concentration of Acid And Alkalis	BS EN ISO 10545-13 ASTM C650	Test Available	UHA
	Color Resisyance to UV Light	DIN 51094	No Change	No Change
	Resistance to Staining	BS EN ISO 10545-14	No Evident Variation	Non Evident
	Lead and Cadumium Leaching	BS EN ISO 10545-15:2000	Lead 0.00 Cadmium0.00	"0.00 0.00"
	Determination of Small Color Differences	BS EN ISO 10545-16	ΔE<1	0.75
	Crazing Resistance Glazed Tile	BS EN ISO 1545-11	No Crazing	No Crazing
Fisical characteristic	Mousture Expznson	BS EN ISO 10545-10	Mm/m	0.03
	Resistance of Freeze	ASTM C 1026-87	Resistant	Resistant
	Shock Resistant	BS EN ISO 10545-5	Resistant	Resistant
Qualtiy surface	Determination Surface Quality	SSA 1031/1998	Without Defict 95%	conform

## GLAZED PORCELAIN STONEWARE

	TEST DESCRIPTION	NORMS	REQUIRED STANDARDS	FUTURE VALUES	
Regularity characteristic	Length and width		± 0.5%	± 0.1%	
	Thickness		± 5%	± 3%	
	Straightness of sides	ISO 10545-2	± 0.5%	± 0.1%	
	Rectangularity		± 0.6%	± 0.2%	
	Surface flatness		± 1%	± 0.2%	
Structural characteristic	Water absorption	ISO 10545-3	≤ 0.5%	≤ 0.2%	
Bulk mechanical characteristic	Breaking strength	ISO 10545-4	S ≥ 1300 N	S ≥ 2300	
	Modulus of rupture		R ≥ 35 N/mm <sup>2</sup>	R = 42 N/mm <sup>2</sup>	
Surface mechanical characteristic	Moh's hardness (scratch)	SSA 1031	≥ 5	9	
Thermal and hygrometric characteristic	Coefficient of thermal linear expansion	ISO 10545-8	≤ 9 MK	6.9 MK	
	Thermal shock resistance	SSA 1031	Test available	Resistant	
	Resistance to frost	ISO 10545-12	Required	Resistant	
Safety characteristic	Dynamic friction coefficient	BRCA	Dry μ > 0.40	μ > 0.53	
	Static coefficient of friction	ASTM C 1028-2007	Slip resistant ≥ 0.60	0.98 Dry 0.63 Wet	
	Non-slip classification	DIN 51130	Ramp Test	R = 10	
Chemical characteristic	Resistance to household chemicals and swimming pool salts		Class UB min	GA	
	Resistance to low concentration of acid and alkalis	ISO 10545-13	Manufacturer to state classification	GLA	
	Resistance to high concentration of acids and alkalis		Test available	GHA	
	Color resistance to uv light	DIN 51094	No change	No change	
	Resistance to staining	ISO 10545-14	No evident variation	Non evident	
	Lead and cadmium leaching	ISO 10545-15:2000	Lead 0.00 Cadmium 0.00	0.00 0.00	
	Determination of small colour differences	ISO 10545-16	ΔE < 1	0.75	
	Crazing resistance glazed tile	ISO 10545-11	Crazing 0	0	
	Fisical characteristic	Moustrure expansion	ISO 10545-10	Mm/m	0.03
		Shock resistant	ISO 10545-5	Resistant	Resistant
Quality surface	Determination surface quality	SSA 1031/1998	Without difect 95%	100%	

## TECHNICAL PORCELAIN FULL BODY

	TEST DESCRIPTION	NORMS	REQUIRED STANDARDS	FUTURE VALUES	
Regularity characteristic	Length and width		± 0.5%	± 0.1%	
	Thickness		± 5%	± 3%	
	Straightness of sides	ISO 10545-2	± 0.5%	± 0.1%	
	Rectangularity		± 0.6%	± 0.2%	
	Surface flatness		± 1%	± 0.2%	
Structural characteristic	Water absorption	ISO 10545-3	≤ 0.1%	≤ 0.05%	
Bulk mechanical characteristic	Breaking strength	ISO 10545-4	S ≥ 1300 N	S ≥ 2300	
	Modulus of rupture		R ≤ 35 N/mm <sup>2</sup>	R = 42 N/mm <sup>2</sup>	
Surface mechanical characteristic	Resistance to deep abrasion	ISO 10545-6 ASTM C-501	≤ 175 mm <sup>3</sup> lw ≥ 100	≤ 123 mm <sup>3</sup> 190	
	Moh's hardness (scratch)	SSA 1031	≥ 6	6	
	Coefficient of thermal linear expansion	ISO 10545-8	≤ 9 MK	7.3 MK	
Thermal and hygrometric characteristic	Thermal shock resistance	ISO 10545-9	Resistant	Resistant	
	Resistance to frost	SSA 1030/1998	Resistant	Resistant	
	Resistance to frost	ISO 10545-12	Required	Resistant	
Safety characteristic	Dynamic friction coefficient	BRCA	Dry μ > 0.40	μ > 0.53	
	Static coefficient of friction	ASTM C 1028-2007	Slip resistant ≥ 0.60	1.0 Dry 0.97 Wet	
	Non-slip classification	DIN 51130	Ramp Test	R = 10	
Chemical characteristic	Resistance to household chemicals and swimming pool salts		Class UB min	UA	
	Resistance to low concentration of acid and alkalis	ISO 10545-13	Manufacturer to state classification	ULA	
	Resistance to high concentration of acids and alkalis		Test available	UHA	
	Color resistance to UV light	DIN 51094	No change	No change	
	Resistance to staining	ISO 10545-14	No evident variation	Non evident	
	Lead and cadmium leaching	ISO 10545-15:2000	Lead 0.00 Cadmium 0.00	0.00 0.00	
	Determination of small colour differences	ISO 10545-16	ΔE < 1	0.75	
	Crazing resistance glazed tile	ISO 10545-11	Crazing 0	0	
	Fisical characteristic	Moustrure expansion	ISO 10545-10	Mm/m	0.03
		Shock resistant	ISO 10545-5	Resistant	Resistant
Quality surface	Determination surface quality	SSA 1031/1998	Without difect 95%	100%	

## Company headquarters

Saudi Arabia – Riyadh P.O.Box 66 Riyadh 11372  
Tel.: +966 11 8103559  
Fax: +966 31 8123100

## Factory

Second Industrial City - Dammam Saudi Arabia,  
Tele: +966 31 8123624  
Fax: +966 31 8123100

## Belda Gallery

Eastern Ring Road - Exit 17 Belda Mall Riyadh,  
Saudi Arabia  
Tel: +966 11 2446363  
Fax: +966 11 4716825

## Al-Kharj Road Gallery

Kharj Road - New Industrial City  
near Yamama Cement Saudi Arabia - Riyadh  
P.O.Box 66  
Tel: +966 11 8103559  
Fax: +966 11 4388517

## Khamis Mushait

Al- Diyafah Quarter , AlBinaa City ,  
Street No. 5 Gallarey 161  
Tel . + 966 17 2226380  
Fax . + 966 17 2226382

## Jeddah Gallery

Almadina Road - After intersection Heraa Road  
Construction City  
Showroom No. B29 , B30  
Tel.: + 966 12 6056662  
Fax: + 966 12 6056634

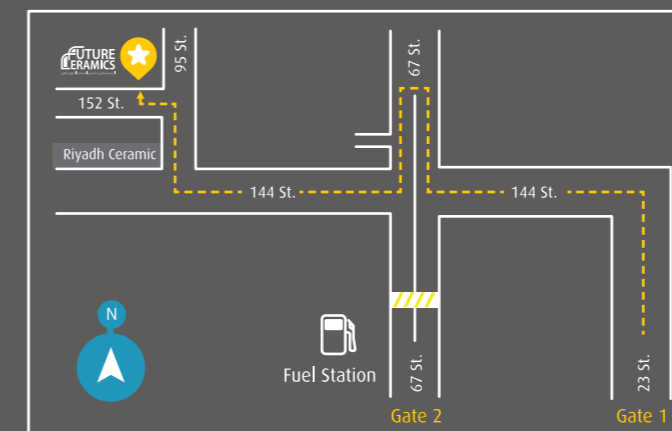

United no.# 920016060  
info@futureceramic.com  
crm@futureceramic.com  
www.futureceramic.com





United no.# 920016060  
[info@futureceramic.com](mailto:info@futureceramic.com)  
[crm@futureceramic.com](mailto:crm@futureceramic.com)  
[www.futureceramic.com](http://www.futureceramic.com)